



KAYPRO TECHNICAL MANUAL

DECEMBER 1984

Part Number 1484-D

CONTENTS

SECTION		PAGE
1.0	Introduction	
1.1	Purpose of Technical Manual	1-1
1.2	Scope of Technical Manual	1-2
2.0	FCC Information	2-1
3.0	Model Specifications	
3.1	KAYPRO 2	3-1
3.2	KAYPRO 2/84 and 2X	3-2
3.3	KAYPRO 4	3-3
3.4	KAYPRO 4/84	3-4
3.5	KAYPRO 4X	3-5
3.6	KAYPRO 10	3-6
3.7	KAYPRO ROBIE	3-7
4.0	ROM Revisions --- CP/M Compatibility	4-1
5.0	Chassis	
5.1	Removal/Replacement of Hood (Exc. ROBIE)	5-1
5.2	Touch-up Information	5-2
6.0	Mainboards--Troubleshooting Tips	6-1
6.1	KAYPRO 2 (81-110-n)	6-2
6.2	KAYPRO 2/4 (81-240-n)	6-8
6.3	KAYPRO 10 (81-180-n)	6-16
6.4	KAYPRO 2/84 and 2X (81-294-n)	6-26
6.5	KAYPRO 4/84 (81-184)	6-35
6.6	KAYPRO ROBIE (81-296-n)	6-44
6.7	Removal/Installation Instructions	6-53
7.0	CRT Assemblies	
7.1	Descriptions and Adjustments	7-1
7.2	Video Alignment	7-3
7.3	Video Signals on KAYPRO Mainboard	7-4
7.4	ALIGN.MAC Diagnostic Listing	7-5
7.5	Removal/Installation Instructions	7-8
8.0	Power Supplies	
8.1	Introduction	8-1
8.2	Description and 220V Configuration	8-2
8.3	Removal/Installation Instructions	8-5

CONTENTS (Continued)

SECTION		PAGE
9.0	Diskette Drives	
9.1	Introduction/Disk Drive Cleaning	9—1
9.2	Which Brand of Drive Is It?	9—2
9.3	Jumpering Diagrams	9—5
9.4	High-Density (Drivetec) Drives	9—9
9.5	Removal/Installation Instructions	9—10
10.0	Hard Disk Drives (KAYPRO 10)	
10.1	Introduction	10—1
10.2	Description	10—2
10.3	Hard Drive Configuration	10—3
10.4	Hard Drive or Floppy Drive Removal/ Installation Instructions (KAYPRO 10)	10—4
11.0	Hard Drive Controller Board (KAYPRO 10)	
11.1	Description	11—1
11.2	Removal/Installation Instructions	11—2
12.0	Interface Board (KAYPRO 10)	
12.1	Description	12—1
12.2	Removal/Installation Instructions	12—2
13.0	Keyboards	13—1
14.0	ROBIE Removal/Installation Instructions	
14.1	Chassis Covers	14—1
14.2	Diskette Drives	14—2
15.0	Troubleshooting	
15.1	Introduction	15—1
15.2	KAYPRO 2 and 4 Symptom—Fix Guides	15—2
15.3	KAYPRO 10 Symptom—Fix Guide	15—8
15.4	ROBIE Symptom—Fix Guide	15—15
15.5	KAYPRO 2/84 and 2X Symptom—Fix Guide	15—21
15.6	KAYPRO 4/84 and 4X Symptom—Fix Guide	15—22

CONTENTS (Continued)

SECTION		PAGE
16.0	System I/O	
16.1	Video Command Protocol	16--1
16.2	Keyboard Codes and Functions	16--2
16.3	Connector Pin-Outs	16--3
16.4	Port Addresses	16--10
17.0	Reference Section	
17.1	ASCII Chart	17--1
17.2	Memory Maps	17--2
17.3	Vendor Addresses	17--6
18.0	Suggested References	18--1
19.0	KAYPRO 16	
19.1	Chassis	19--3
19.2	System Boards	19--4
19.23	Board Assembly Removal	19--16
19.24	Card Removal	19--18
19.25	Mainboard Removal	19--21
19.26	Disk Controller Board Removal	19--22
19.3	CRT Assembly	19--23
19.33	CRT Removal	19--24
19.4	Power Supply	19--26
19.43	Power Supply Removal	19--29
19.5	Diskette Drives	19--31
19.53	Diskette Drive Removal	19--32
19.6	Hard Disk Drive	19--37
19.63	Hard Disk Drive Removal	19--38
19.7	Keyboard	19--41
19.8	System I/O	19--42
19.81	Parallel Printer Cable	19--42
19.84	Serial Printer Cable	19--44
19.86	Modem Cable	19--45
19.92	I/O Port Addresses	19--48
19.93	Memory Map	19--49
19.94	Switch Settings	19--50
19.95	Memory Expansion	19--52

1.0 INTRODUCTION

1.1 PURPOSE OF TECHNICAL MANUAL

This publication is intended to be a technical reference guide to be used by trained repair technicians. It will attempt to cover all dealer-serviceable sections of Kaypro computers. This manual replaces previous manuals on the subject.

The procedures and information contained in this manual assume technical expertise on the part of the reader. To avoid personal injury, do not perform any servicing unless you are a qualified service technician.

It is our desire to provide dealers with the information and support needed to expedite repairs and provide the users with the service they deserve. We encourage your comments and suggestions regarding this manual.

1.2 SCOPE OF TECHNICAL MANUAL

The information and procedures covered by this manual assume some technical knowledge on the part of the reader.

The policy of Kaypro Corporation is to repair computers to the modular level only. Even Kaypro's repair technicians do not repair switching power supplies, CRT assemblies, or disk drives. Repairs to modular components not manufactured by Kaypro Corporation (power supplies, CRT assemblies, disk drives) are NOT covered by this manual.

However, we do not discourage dealers and technicians who have the knowledge and the tools to repair to the component level from doing so, on out-of-warranty Kaypro computers.

The adjustment and removal/replacement information in this manual is organized by module type, with the exception of removal/replacement information for the KAYPRO ROBIE, which is placed in a separate section due to the differences in chassis design and hardware module placement in that machine.

5.0 HARDWARE MODULES

—> COLORED TAB HERE: HARDWARE

2.0 FCC INFORMATION

As Kaypro keeps in step with computer technology, the models have changes which affect FCC ratings. The proper rating is affixed to the back of each computer. Contact the Kaypro Engineering Department if you need further information.

3.0 MODEL SPECIFICATIONS

3.1 KAYPRO 2 SPECIFICATIONS

CPU	Z-80 2.5 MHz
RAM	64K bytes
MAINBOARD	81-110-n or 81-240-n series.
DISK STORAGE	Two 5-1/4 inch, double-density, single-sided, floppy disk drives, providing 191K bytes of storage per diskette.
KEYBOARD	Detachable, 72 key typewriter style keyboard with 18 programmable keys.
VIDEO SCREEN	Non-glare, 9-inch, green phosphor screen with a 25 row x 80 column display.
I/O CONNECTIONS	One "Centronics"-type parallel port, one RS-232C serial port.

3.2 KAYPRO 2/84 and 2X SPECIFICATIONS

CPU	Z80-A 4.0 MHz
RAM	64K bytes
MAINBOARD	81-294-n series.
DISK STORAGE (Kaypro 2/84)	Two 5-1/4 inch double-density, single-sided, floppy disk drives, providing 191K bytes of storage per diskette.
DISK STORAGE (Kaypro 2X)	Two 5-1/4 inch double-density, double-sided, floppy disk drives, providing 390K bytes of storage per diskette.
KEYBOARD	Detachable, 72 key typewriter style keyboard with 18 programmable keys.
VIDEO SCREEN	Non-glare, 9-inch, green phosphor screen with a 25 row x 80 column display.
I/O CONNECTIONS	One "Centronics"-type parallel port, two RS-232C serial ports.

3.3 KAYPRO 4 SPECIFICATIONS

CPU	Z-80 2.5 MHz
RAM	64K bytes
MAINBOARD	81-240-n series.
DISK STORAGE	Two 5-1/4 inch double-density, double-sided, floppy disk drives, providing 390K bytes of storage per diskette.
KEYBOARD	Detachable, 72 key typewriter style keyboard with 18 programmable keys.
VIDEO SCREEN	Non-glare, 9-inch, green phosphor screen with a 25 row x 80 column display.
I/O CONNECTIONS	One "Centronics"-type parallel port, one RS-232C serial port.

3.4 KAYPRO 4/84 SPECIFICATIONS

CPU	Z-80A 4.0 MHz
RAM	64K bytes
MAINBOARD	81-184-n series.
DISK STORAGE	Two double-density, double-sided, floppy disk drives, providing 390K bytes of storage per diskette.
KEYBOARD	Detachable, 72 key typewriter style keyboard with 18 programmable keys.
VIDEO SCREEN	Non-glare, 9-inch green phosphor screen with a 25 row x 80 column display.
I/O CONNECTIONS	One "Centronics"-type parallel port, two RS-232C serial ports, one RJ11C modular telephone jack.
MODEM	Built-in, 300-baud modem, with Bell System 103 compatibility. Uses Texas Instruments TMS99531/TMS99532.
REAL-TIME CLOCK	Built-in real-time clock. Uses National MM58167.

3.5 KAYPRO 4X SPECIFICATIONS

CPU	Z-80A 4.0 MHz
RAM	64K bytes
MAINBOARD	81-296-n series.
DISK STORAGE	Two 5-1/4 inch, high-density, double-sided, floppy disk drives providing 2.6M bytes of storage per diskette.
KEYBOARD	Detachable, 72 key typewriter style keyboard with 18 programmable keys.
VIDEO SCREEN	Non-glare, 9-inch, green phosphor screen with a 25 row x 80 column display.
I/O CONNECTIONS	One "Centronics"-type parallel port, two RS-232C serial ports, one RJ11C modular telephone jack.
MODEM	Built-in, 300-baud modem, with Bell System 103 compatibility. Uses Texas Instruments TMS99531/TMS99532.
REAL-TIME CLOCK	Built-in real-time clock. Uses National MM58167.

3.6 KAYPRO 10 SPECIFICATIONS

CPU	Z80A, 4.0 MHz
RAM	64K bytes
MAINBOARD	81-180-n series.
DISK STORAGE	One 5-1/4 inch double-density, double-sided, floppy disk drive providing 390K bytes of storage per diskette. One hard disk drive providing 10M bytes of storage.
KEYBOARD	Detachable, 72 key typewriter style keyboard with 18 programmable keys.
VIDEO SCREEN	Non-glare, 9-inch, green phosphor screen with a 25 row x 80 column display.
I/O CONNECTIONS	One "Centronics"-type parallel port, two RS-232C serial ports.

3.7 KAYPRO ROBBIE SPECIFICATIONS

CPU	Z80A, 4.0 MHz
RAM	64K bytes
MAINBOARD	81-296-n series.
DISK STORAGE	Two 5-1/4 inch, high-density, double-sided, floppy disk drives providing 2.6M bytes of storage per diskette.
KEYBOARD	Detachable, 72 key typewriter style keyboard with 18 programmable keys.
VIDEO SCREEN	Non-glare, 9-inch, green phosphor screen with a 25 row x 80 column display.
I/O CONNECTIONS	One "Centronics" type parallel port, two RS232C serial ports, one RJ11C modular telephone jack.
MODEM	Built-in, 300-baud modem, with Bell System 103 compatibility. Uses Texas Instruments TMS99531/TMS99532.
REAL-TIME CLOCK	Built-in real-time clock. Uses National MM58167.

4.0 KAYPRO ROM REVISION—CP/M VERSION COMPATIBILITY

MODEL NAME	CP/M VERSION	KAYPRO PART # (for CP/M disk)	ROM VERSION
2/83	2.2F	0777	81-149-C or 81-232-A
4/83	2.2F	1475	81-232-A
4/83 + 88	2.2F	1475	81-232-A
2/84	2.2G	2619	81-292-A
4/84	2.2G	2622	81-292-A
4/84 + 88	2.2G	2622	81-292-A
2 X	2.2G	2470	81-292-A
4 X	2.2G	2340	81-326-E
ROBIE	2.2G	2340	81-326-E

---> COLORED TAB: TROUBLESHOOTING

5.0 CHASSIS

5.1 CHASSIS HOOD REMOVAL (EXCEPT KAYPRO ROBIE)

1. Turn off the machine.
2. Disconnect AC power by unplugging the power cord from wall outlet.
3. Remove the ten screws from the chassis hood; there are two on top and four on each side.
4. Remove the hood from the chassis.

CHASSIS HOOD REPLACEMENT

1. Lower the hood onto the unit.
2. Align the two holes on top of the hood with those on top of the chassis.
3. Insert the two flat-head screws into the holes on the top of the chassis and start them, but do not tighten them yet.
4. Insert the eight round-head screws, four on each side, and start them.
5. Tighten each screw securely.

5.2 TOUCH-UP INFORMATION

Kaypro Corporation has small amounts of touch-up paint for Kaypro hoods and chassis available to the dealers. Contact the Hardware Technical Support personnel to obtain this paint.

Occasionally a customer's computer will have scratches on the hood or chassis. A small amount of rubbing compound, when carefully applied, will often smooth out very small scratches on a hood or chassis. Should painting be necessary, there are two sizes of sable paintbrushes to have on hand: size 00 and size 000. These brushes are available at any art supply store.

6.0 MAINBOARDS

The following sections contain schematics, chip layout diagrams, and IC lists (by U-number) for Kaypro mainboards. This is not intended to be a theory of operation, but rather an aid to locating possible problems on a mainboard.

Consult an appropriate databook (TTL, Zilog, etc.) if you need to find out the internal workings of a particular IC.

MAINBOARD TROUBLESHOOTING TIPS:

A blank EPROM can be used to help troubleshoot Kaypro mainboards of series 81-110, 81-240, and 81-180. The appropriate model of EPROM (2732, 2716, etc) allows a quick check of the board. It will usually force the data and address lines to toggle at approximately the same amplitude, allowing the technician to use a scope to spot affected lines.

If the video display does not show a screen filled with alternating "9"s and apostrophes, you have a problem in the video RAM or associated circuitry.

You can check the main RAM and associated circuitry quickly with a scope by looking at pin 14 on each of the RAM chips. There should be a pattern of signals like this:

For the 81-240 board:

U20 (D7)	low
U21 (D6)	low
U22 (D5)	toggle
U23 (D4)	toggle
U24 (D3)	toggle
U25 (D2)	low
U26 (D1)	low
U27 (D0)	toggle

The U-numbers of the main RAM chips will vary depending on which mainboard you have, but the pattern will be the same.

6.1 KAYPRO 2 (81-110-n)

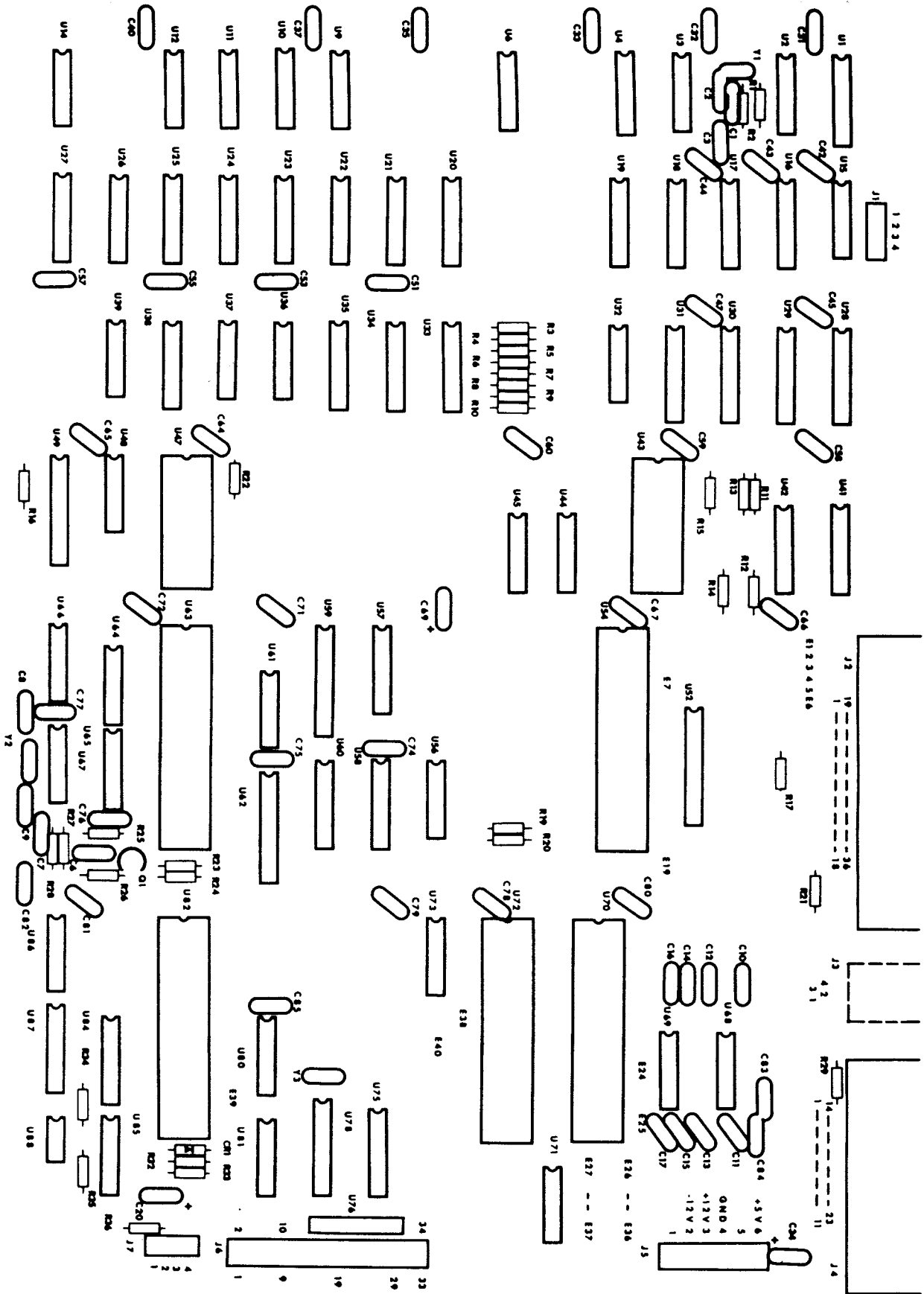

IC LIST, KAYPRO 2 (81-110-n)

Reference Designation		Description
U1	74LS161	4-bit counter
U2, U67*	74HCU04	Hex inverter, CMOS
U3	74LS290	decade counter
U4	74LS10	Tri NAND gates
U6, U11	74LS393	Dual binary counter
U9, U80	74LS08	Quad AND gates
U10, U61	73LS32	Quad OR Gates
U12, U14, U32	74LS74	Dual "D" flip-flop
U15, U39	74LS00	Quad NAND Gates
U16 through U19	74LS157	Quad 2/1 MUX
U20 through U27	MCM6665	(or equivalent) 64K x 1 RAM
U28 through U31	2114	1K x 4 RAM
U33, U34	74157	Quad 2/1 MUX
U35, U38	8216	Quad Bi-directional MUX
U36	74LS20	Dual NAND gates
U37, U56, U85	74LS02	Quad NOR gates
U41	74S151	8/1 MUX
U42	74LS174	Hex "D" flip-flop
U43	81-146	Character generator EPROM
U44, U45, U64, U65	74LS243	Quad bus trans
U47	81-149	Boot EPROM
U48, U73	74LS04	Hex inverter
U49, U52, U62	74LS241	Octal buffer
U54, U72	Z80 PIO	
U57, U58, U60	74LS138	3/8 MUX
U59	74LS373	Octal "D" latch
U63	Z80 CPU	
U66	74164	8-bit shift register
U68	1488	Quad line driver (OUT)
U69	1489	Quad SCHMITT line receiver (IN)
U70	Z80 SIO	
U71	74S04	Hex inverter
U78	8116	Dual programmable baud rate generator
U81	7406	Hex inverter, open collector
U82	FD1793	Floppy disk controller
U84	74LS195	4-bit shift register
U86	74LS293	4-bit binary counter
U87	74LS390	Dual decade counter
U88	FDC9216	Data separator

*NOTE: THERE ARE SOME VERSIONS OF THE 81-110 BOARD ON WHICH U2 AND U67 ARE NOT CMOS IC.S BUT ARE NORMAL TTL IC.S. READ THE NUMBER ON THE IC TO BE SURE.

SCOPE SIGNALS TO AID IN TROUBLESHOOTING (81-110-n)

The examples of correct signals shown below do not represent all of the signals on a Kaypro mainboard, since most signals will be simple high-low toggles. A group of video signals (CC0 through CC3) are included as illustrations of the timing relationships between the various video signals. Note that only one of the I/O signals on U57 will be low at any given time.

State of the machine: The door of drive A is open; the machine is waiting to boot.

The signal measurements were made using a Tektronix oscilloscope, model 2213. It has a bandwidth of DC-60 MHz, sensitivity of 2mV/cm, a sweep delay of 0.1 microseconds to 1 second, and a graticule display measuring 8 x 10 cm.

Signal M1 from pin 27 of the CPU (U63) was triggered on. This signal is shown in the top half of each display and was channel 1. Ground for the signals shown on channel 2 was established at first graticule line above the bottom of the display.

Each square of the representation is the equivalent of one square cm on the graticule. The scope was set for 2V/div. for all figures, and was set for .5 micro-secs/div. for all figures EXCEPT figure 6, which was taken using 1 micro-secs/div.

Figure 1: Pin 6 of U63, 2.5MHz clock signal.

Figure 2: Pin 24 of U82, 1MHz clock signal.

Figure 3: Pin 3 of U6, CC0.

Figure 4: Pin 4 of U6, CC1.

Figure 5: Pin 5 of U6, CC2.

Figure 6: Pin 6 of U6, CC3.

FIGURE 1

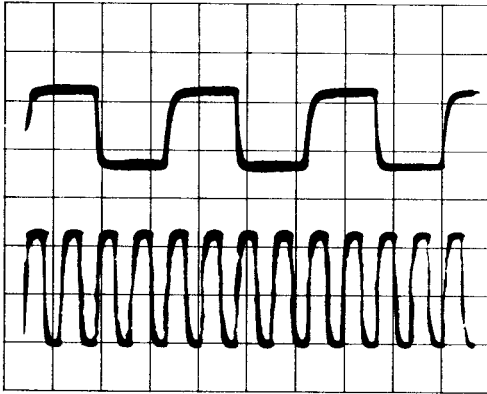

FIGURE 2

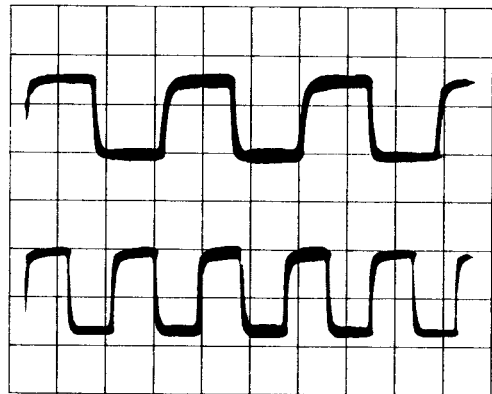

FIGURE 3

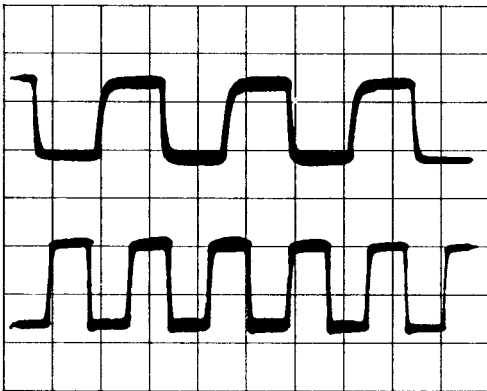

FIGURE 4

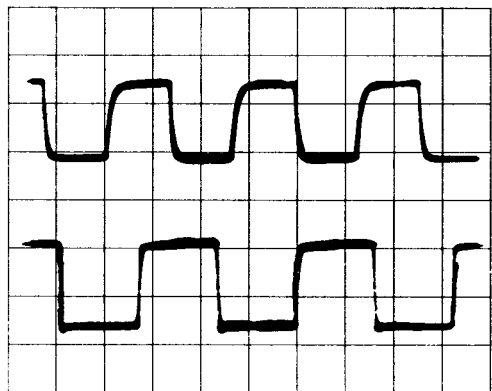

FIGURE 5

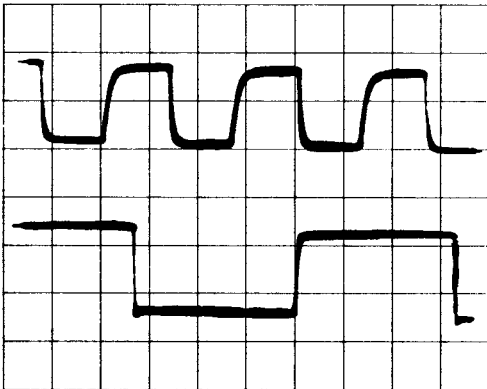
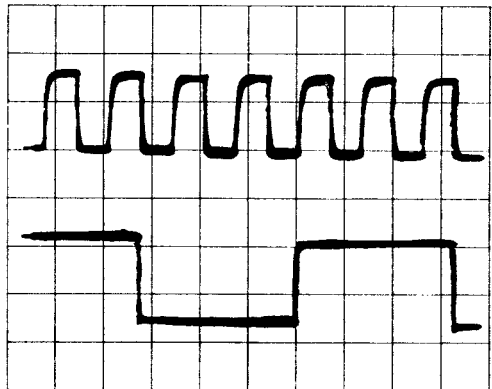
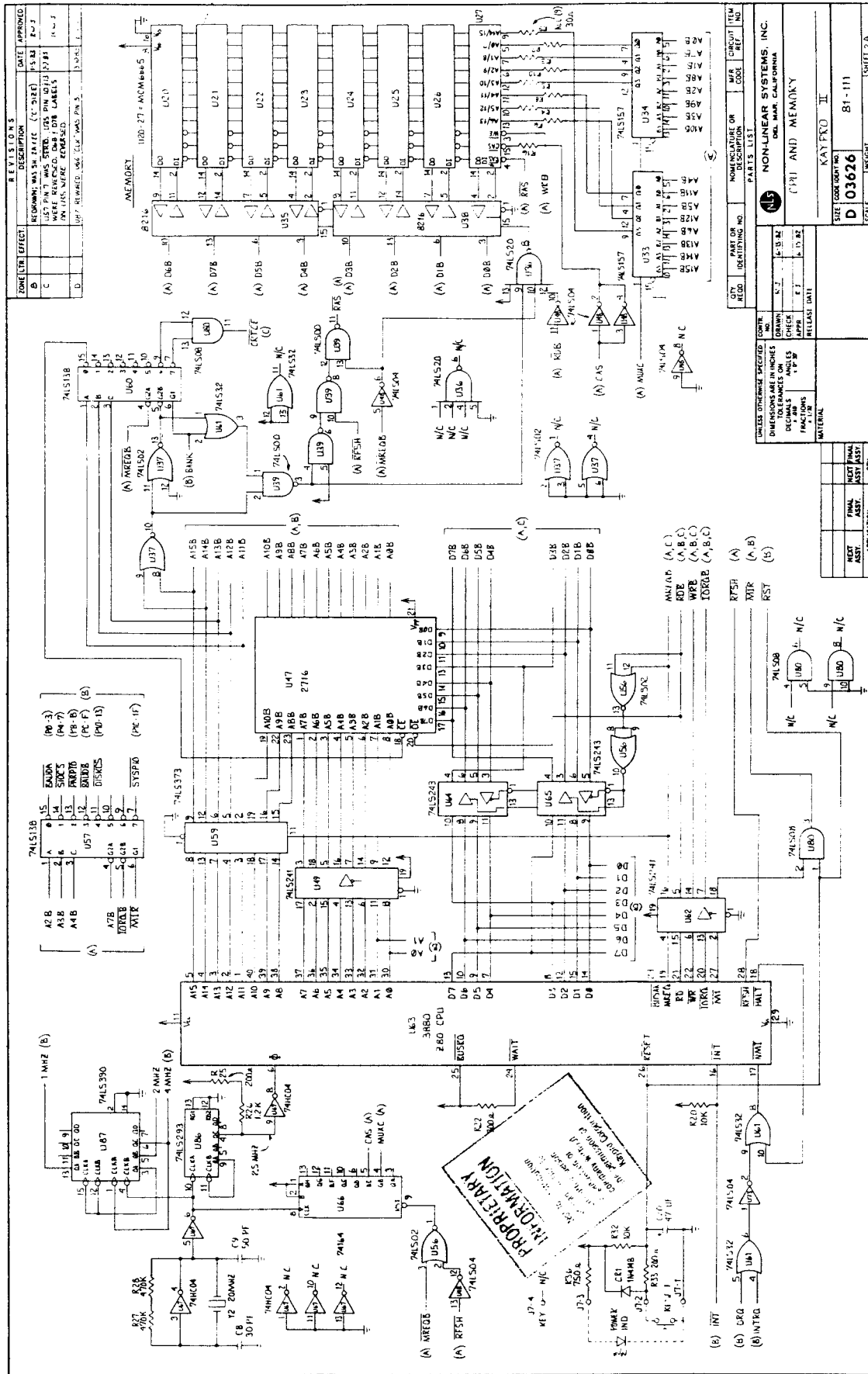

FIGURE 6



SIGNAL LOCATIONS ON MAINBOARD 81-110-n

<u>SIGNAL</u>	<u>IC</u> <u>LOCATION</u>	<u>PIN NO.</u>
CPU SIGNALS		
2.5 MHz	U 63	6
MREQB	U 62	16
RDB	U 62	5
WRB	U 62	14
MEMORY SIGNALS		
RAS	U 39	11
CAS	U 66	5
MUXC	U 66	4
VIDEO CLOCK SIGNALS		
CLOCK, Y1	U 2	8
CC0	U 6	3
CC1	U 6	4
CC2	U 6	5
CC3	U 6	6



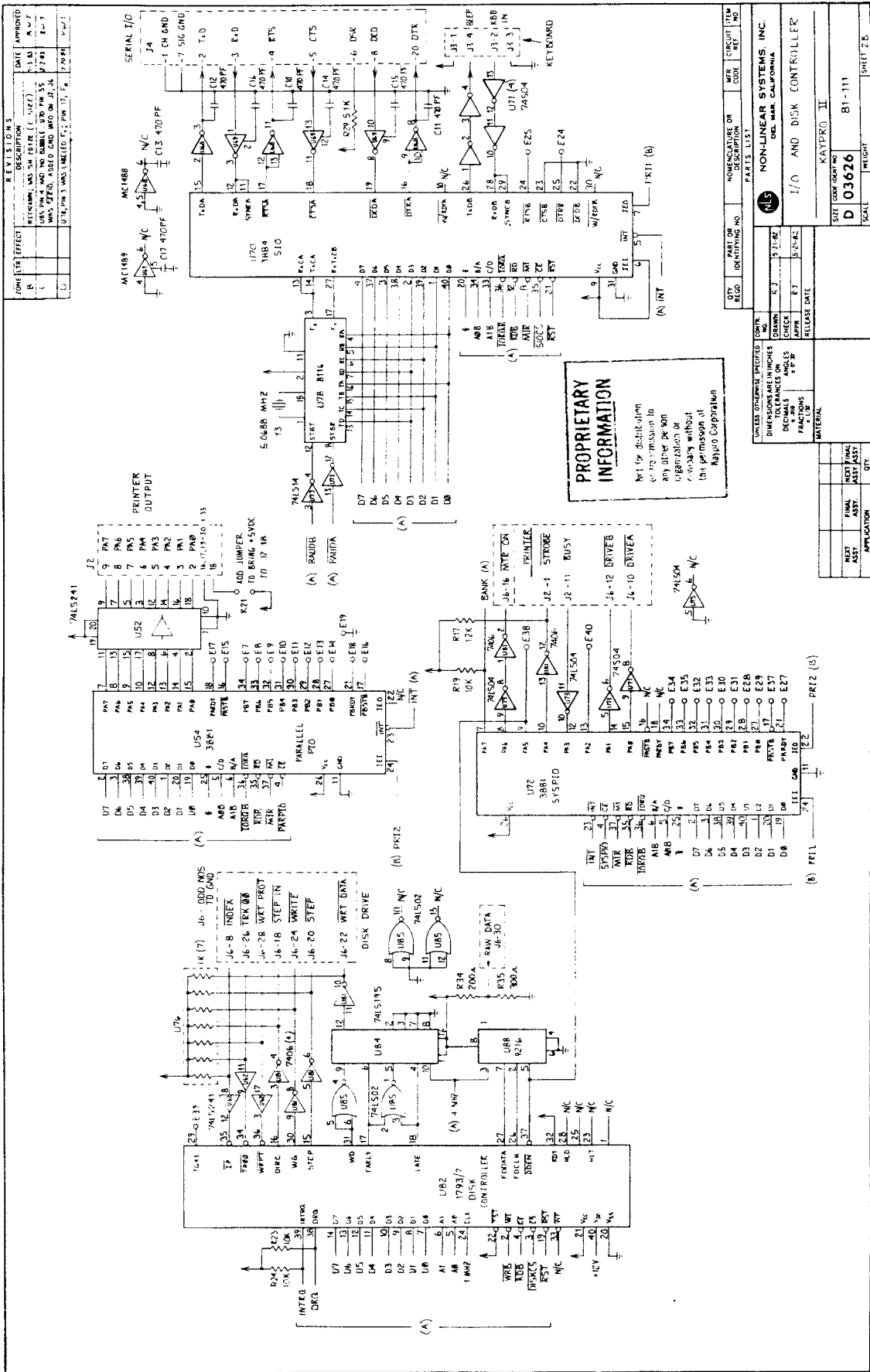

REV	DATE	DESCRIPTION	APPROVED
1	1-3-67	REVISION: WAS SH 1012E (C-112E2)	
2	1-10-67	U7R PIN 4 AND NO DOUBLE 120 OHM 5%	
3	2-7-67	WAS OFFED, ADDED GND W/O ON J2, J4	
4	2-7-67	U7R, PMS WAS UNLABLED P1, P2, P3, P4	

QTY	PART OR IDENTIFYING NO.	NOMENCLATURE OR PARTS LIST	MANUFACTURE OR SOURCE
1	U7R	BITL	74LS04
1	U7A	74LS04	74LS04
1	U7B	74LS04	74LS04
1	U7C	74LS04	74LS04
1	U7D	74LS04	74LS04
1	U7E	74LS04	74LS04
1	U7F	74LS04	74LS04
1	U7G	74LS04	74LS04
1	U7H	74LS04	74LS04
1	U7I	74LS04	74LS04
1	U7J	74LS04	74LS04
1	U7K	74LS04	74LS04
1	U7L	74LS04	74LS04
1	U7M	74LS04	74LS04
1	U7N	74LS04	74LS04
1	U7O	74LS04	74LS04
1	U7P	74LS04	74LS04
1	U7Q	74LS04	74LS04
1	U7R	74LS04	74LS04
1	U7S	74LS04	74LS04
1	U7T	74LS04	74LS04
1	U7U	74LS04	74LS04
1	U7V	74LS04	74LS04
1	U7W	74LS04	74LS04
1	U7X	74LS04	74LS04
1	U7Y	74LS04	74LS04
1	U7Z	74LS04	74LS04

NO.	QTY	DESCRIPTION	DATE
1	1	U7R BITL	1-3-67
2	1	U7A 74LS04	1-3-67
3	1	U7B 74LS04	1-3-67
4	1	U7C 74LS04	1-3-67
5	1	U7D 74LS04	1-3-67
6	1	U7E 74LS04	1-3-67
7	1	U7F 74LS04	1-3-67
8	1	U7G 74LS04	1-3-67
9	1	U7H 74LS04	1-3-67
10	1	U7I 74LS04	1-3-67
11	1	U7J 74LS04	1-3-67
12	1	U7K 74LS04	1-3-67
13	1	U7L 74LS04	1-3-67
14	1	U7M 74LS04	1-3-67
15	1	U7N 74LS04	1-3-67
16	1	U7O 74LS04	1-3-67
17	1	U7P 74LS04	1-3-67
18	1	U7Q 74LS04	1-3-67
19	1	U7R 74LS04	1-3-67
20	1	U7S 74LS04	1-3-67
21	1	U7T 74LS04	1-3-67
22	1	U7U 74LS04	1-3-67
23	1	U7V 74LS04	1-3-67
24	1	U7W 74LS04	1-3-67
25	1	U7X 74LS04	1-3-67
26	1	U7Y 74LS04	1-3-67
27	1	U7Z 74LS04	1-3-67

NO.	QTY	DESCRIPTION	DATE
1	1	U7R BITL	1-3-67
2	1	U7A 74LS04	1-3-67
3	1	U7B 74LS04	1-3-67
4	1	U7C 74LS04	1-3-67
5	1	U7D 74LS04	1-3-67
6	1	U7E 74LS04	1-3-67
7	1	U7F 74LS04	1-3-67
8	1	U7G 74LS04	1-3-67
9	1	U7H 74LS04	1-3-67
10	1	U7I 74LS04	1-3-67
11	1	U7J 74LS04	1-3-67
12	1	U7K 74LS04	1-3-67
13	1	U7L 74LS04	1-3-67
14	1	U7M 74LS04	1-3-67
15	1	U7N 74LS04	1-3-67
16	1	U7O 74LS04	1-3-67
17	1	U7P 74LS04	1-3-67
18	1	U7Q 74LS04	1-3-67
19	1	U7R 74LS04	1-3-67
20	1	U7S 74LS04	1-3-67
21	1	U7T 74LS04	1-3-67
22	1	U7U 74LS04	1-3-67
23	1	U7V 74LS04	1-3-67
24	1	U7W 74LS04	1-3-67
25	1	U7X 74LS04	1-3-67
26	1	U7Y 74LS04	1-3-67
27	1	U7Z 74LS04	1-3-67

NO.	QTY	DESCRIPTION	DATE
1	1	U7R BITL	1-3-67
2	1	U7A 74LS04	1-3-67
3	1	U7B 74LS04	1-3-67
4	1	U7C 74LS04	1-3-67
5	1	U7D 74LS04	1-3-67
6	1	U7E 74LS04	1-3-67
7	1	U7F 74LS04	1-3-67
8	1	U7G 74LS04	1-3-67
9	1	U7H 74LS04	1-3-67
10	1	U7I 74LS04	1-3-67
11	1	U7J 74LS04	1-3-67
12	1	U7K 74LS04	1-3-67
13	1	U7L 74LS04	1-3-67
14	1	U7M 74LS04	1-3-67
15	1	U7N 74LS04	1-3-67
16	1	U7O 74LS04	1-3-67
17	1	U7P 74LS04	1-3-67
18	1	U7Q 74LS04	1-3-67
19	1	U7R 74LS04	1-3-67
20	1	U7S 74LS04	1-3-67
21	1	U7T 74LS04	1-3-67
22	1	U7U 74LS04	1-3-67
23	1	U7V 74LS04	1-3-67
24	1	U7W 74LS04	1-3-67
25	1	U7X 74LS04	1-3-67
26	1	U7Y 74LS04	1-3-67
27	1	U7Z 74LS04	1-3-67

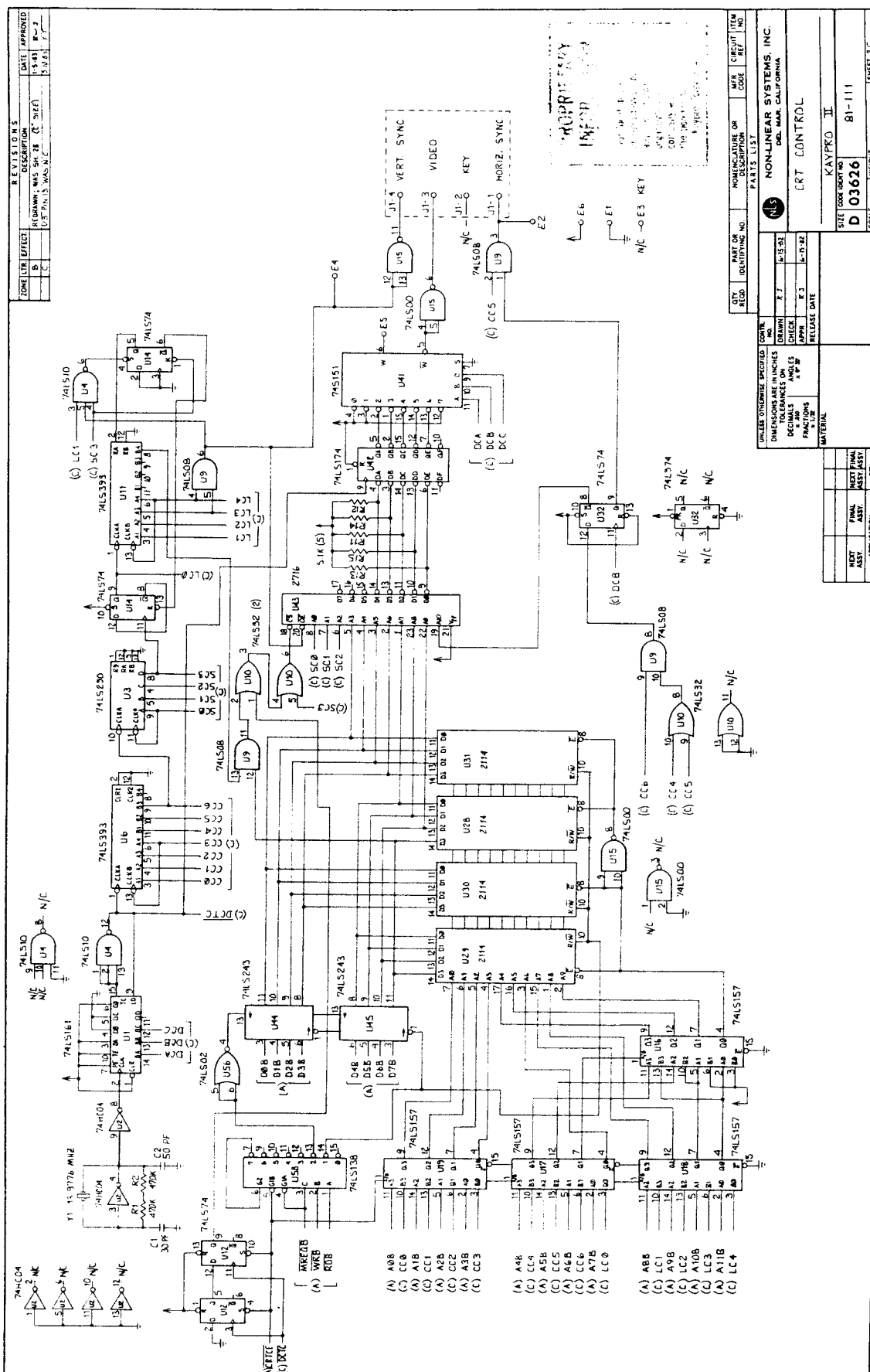

REVISIONS		DATE APPROVED	
NO.	DESCRIPTION	BY	DATE
1	DESIGN	W.S. SHAW (C. SHEP)	3/1/61
2	REVISIONS	W.S. SHAW	3/1/61

CORE LINE EFFECT		NON-ENCLOSURE OR PARTS LIST	
NO.	DESCRIPTION	NO.	DESCRIPTION
1		1	
2		2	

DIMENSIONS		TOLERANCES	
NO.	DESCRIPTION	NO.	DESCRIPTION
1		1	
2		2	

DIMENSIONS		TOLERANCES	
NO.	DESCRIPTION	NO.	DESCRIPTION
1		1	
2		2	

DIMENSIONS		TOLERANCES	
NO.	DESCRIPTION	NO.	DESCRIPTION
1		1	
2		2	

DIMENSIONS		TOLERANCES	
NO.	DESCRIPTION	NO.	DESCRIPTION
1		1	
2		2	

DIMENSIONS		TOLERANCES	
NO.	DESCRIPTION	NO.	DESCRIPTION
1		1	
2		2	

DIMENSIONS		TOLERANCES	
NO.	DESCRIPTION	NO.	DESCRIPTION
1		1	
2		2	

DIMENSIONS		TOLERANCES	
NO.	DESCRIPTION	NO.	DESCRIPTION
1		1	
2		2	

DIMENSIONS		TOLERANCES	
NO.	DESCRIPTION	NO.	DESCRIPTION
1		1	
2		2	

DIMENSIONS		TOLERANCES	
NO.	DESCRIPTION	NO.	DESCRIPTION
1		1	
2		2	

DIMENSIONS		TOLERANCES	
NO.	DESCRIPTION	NO.	DESCRIPTION
1		1	
2		2	

DIMENSIONS		TOLERANCES	
NO.	DESCRIPTION	NO.	DESCRIPTION
1		1	
2		2	

DIMENSIONS		TOLERANCES	
NO.	DESCRIPTION	NO.	DESCRIPTION
1		1	
2		2	

DIMENSIONS		TOLERANCES	
NO.	DESCRIPTION	NO.	DESCRIPTION
1		1	
2		2	

DIMENSIONS		TOLERANCES	
NO.	DESCRIPTION	NO.	DESCRIPTION
1		1	
2		2	

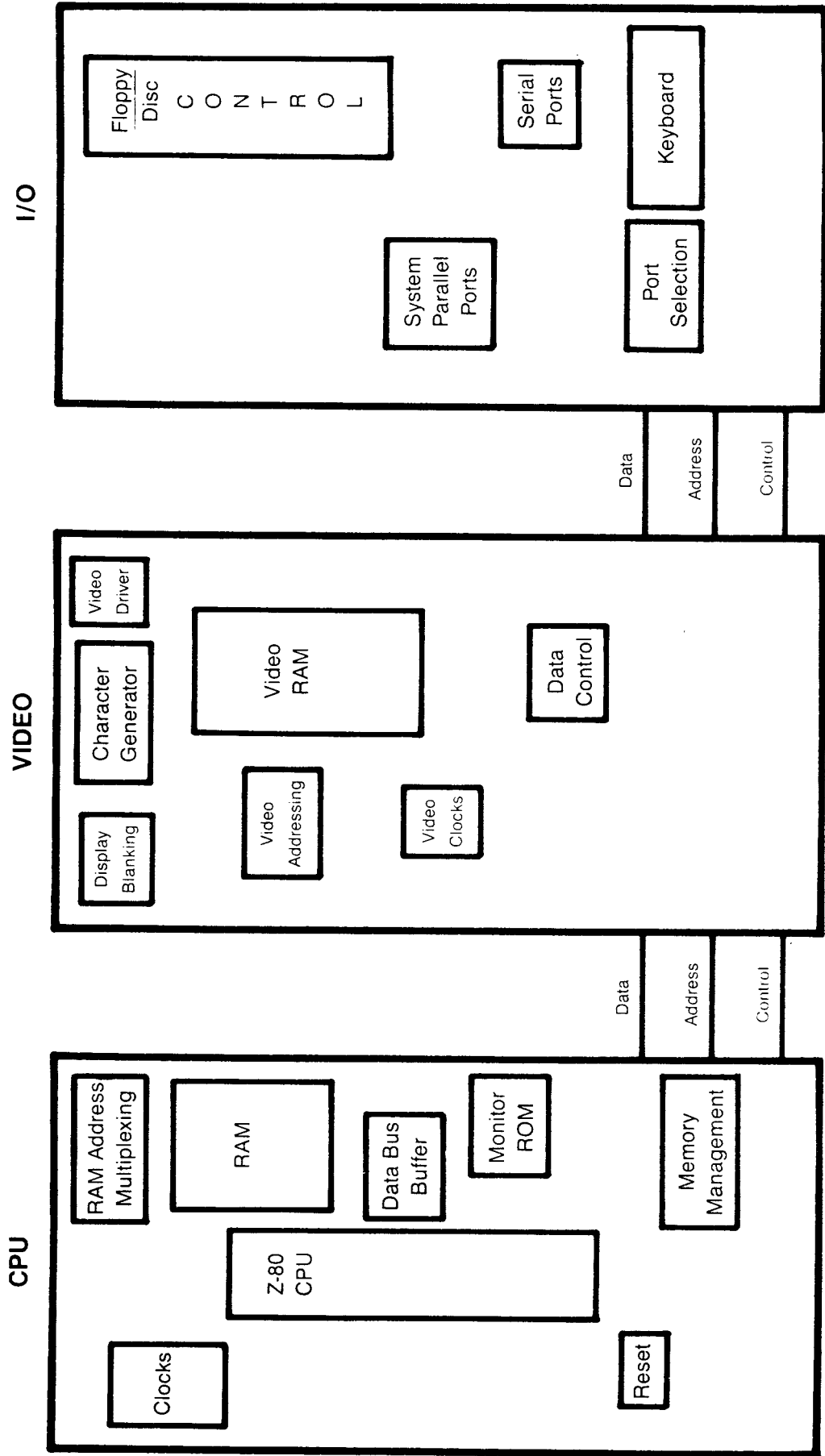

KAYPRO 2 and 4 BLOCK DIAGRAM

6.2 KAYPRO 2/4 (81-240-n)

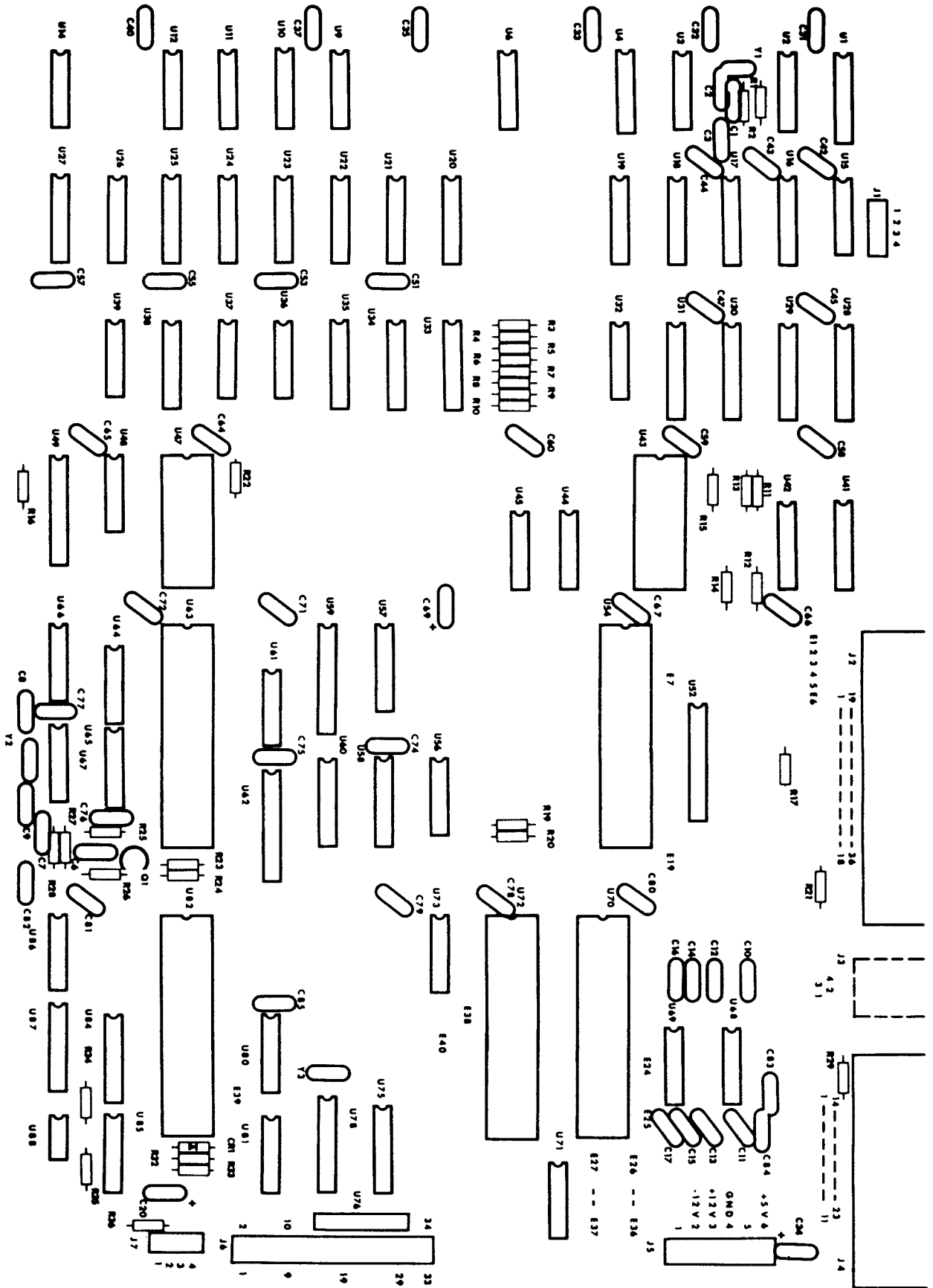

IC LIST, KAYPRO 2/4 (81-240-n)

Reference Designation		Description
U1	74LS161	4-bit counter
U2, U67	74HC04	Hex inverter, CMOS
U3	74LS290	Decade counter
U4	74LS10	Tri NAND gates
U6, U11	74LS393	Dual binary counter
U9, U80	74LS08	Quad AND gates
U10, U61	73LS32	Quad OR Gates
U12, U14, U32	74LS74	Dual "D" flip-flop
U15, U39	74LS00	Quad NAND Gates
U16 through U19	74LS157	Quad 2/1 MUX
U20 through U27	MCM6665	(or equivalent) 64K x 1 RAM
U28 through U31	2114	1K x 4 RAM
U33, U34	74157	Quad 2/1 MUX
U35, U38	8216	Quad Bi-directional MUX
U36	74LS20	Dual NAND gates
U37, U56, U85	74LS02	Quad NOR gates
U41	74S151	8/1 MUX
U42	74LS174	Hex "D" flip-flop
U43	81-146-n	Character generator EPROM
U44, U45, U64, U65	74LS243	Quad bus trans
U47	81-232-n	Boot EPROM
U48, U73	74LS04	Hex inverter
U49, U52, U62	74LS241	Octal buffer
U54, U72	Z80 PIO	
U57, U58, U60	74LS138	3/8 MUX
U59	74LS373	Octal "D" latch
U63	Z80 CPU	
U66	74164	8-bit shift register
U68	MC1488	Quad line driver (OUT)
U69	MC1489	Quad SCHMITT line receiver (IN)
U70	Z80 SIO	
U71	74S04	Hex inverter
U78	8116	Dual programmable baud rate generator
U81	7406	Hex inverter, open collector
U82	1793	Floppy disk controller
U84	74LS195	4-bit shift register
U86	74LS293	4-bit binary counter
U87	74LS390	Dual decade counter
U88	FDC9216	Data separator

SCOPE SIGNALS FOR TROUBLESHOOTING 81-240-n

The examples of correct signals shown below do not represent all of the signals on a Kaypro mainboard, since most signals will be simple high-low toggles. A group of video signals (CC0 through CC3) are included as illustrations of the timing relationships between the various video signals. Note that only one of the I/O signals on U57 will be low at any given time.

State of the machine: with a blank, 2732, EPROM inserted in place of normal EPROM at location U 47. The door of drive A is open; the machine is waiting to boot.

The signal measurements were made using a Tektronix oscilloscope, model 2213. It has a bandwidth of DC-60 MHz, sensitivity of 2mV/cm, a sweep delay of 0.1 microseconds to 1 second, and a graticule display measuring 8 x 10 cm.

Signal M1 from pin 27 of the CPU (U63) was triggered on. This signal is shown in the top half of each display and was channel 1. Ground for the signals shown on channel 2 was established at first graticule line above the bottom of the display.

Each square of the representation is the equivalent of one square cm on the graticule. The scope was set for 2V/div. for all figures, and was set for .5 micro-secs/div. for all figures EXCEPT figure 6, which was taken using 1 micro-secs/div.

Figure 1: Pin 6 of U63, 2.5MHz clock signal.

Figure 2: Pin 24 of U82, 1MHz clock signal.

Figure 3: Pin 3 of U6, CC0.

Figure 4: Pin 4 of U6, CC1.

Figure 5: Pin 5 of U6, CC2.

Figure 6: Pin 6 of U6, CC3.

FIGURE 1

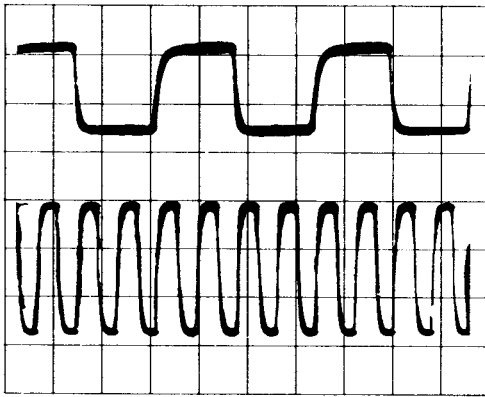

FIGURE 2

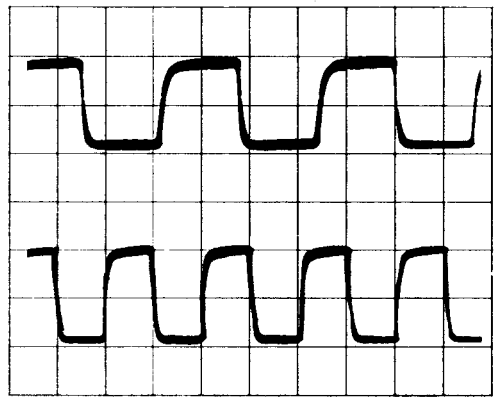

FIGURE 3

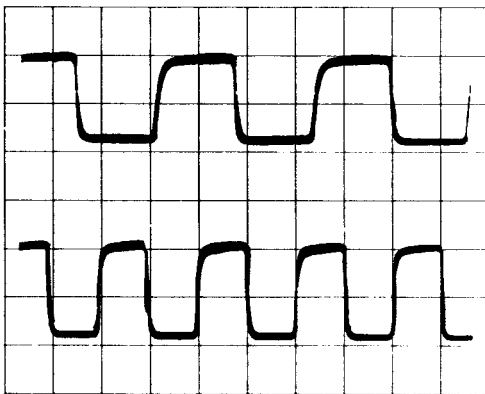

FIGURE 4

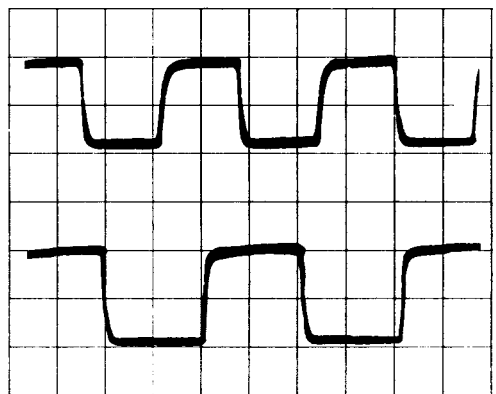

FIGURE 5

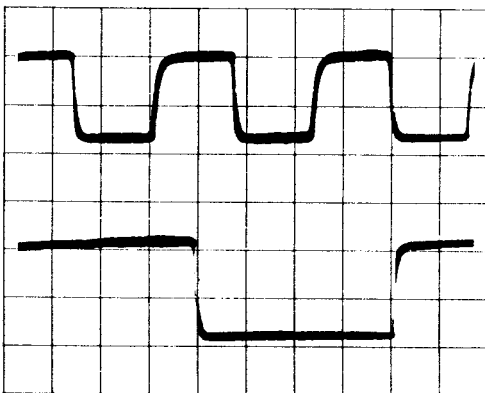
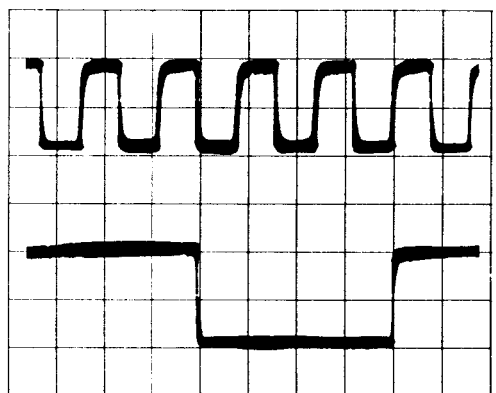

FIGURE 6



SIGNAL LOCATIONS, 81-240-n

<u>SIGNAL</u>	<u>IC</u> <u>LOCATION</u>	<u>PIN NO.</u>
CPU SIGNALS		
CPU clock	U 67	6
1 MHz	U 87	13
2 MHz	U 87	3
MREQB	U 62	16
RDB	U 62	5
MIR (reference)		
MEMORY SIGNALS		
RAS	U 39	11
CAS	U 66	5
MUXC	U 66	4
VIDEO CLOCK SIGNALS		
CLOCK, Y1	U 2	8
CC0	U 6	3
CC1	U 6	4
CC2	U 6	5
CC3	U 6	6

DATE	DESCRIPTION	APPROVED
B	REWORK: WAS SH ENTER (1' SIZE)	R.W.T
C	UBS PMA AND NO CHANGE. DRD PMA 35	R.W.T
D	WAS DEFO. ADDED AND DRD PMA 35	R.W.T
E	WAS DEFO. ADDED AND DRD PMA 35	R.W.T
F	WAS DEFO. ADDED AND DRD PMA 35	R.W.T
G	WAS DEFO. ADDED AND DRD PMA 35	R.W.T
H	WAS DEFO. ADDED AND DRD PMA 35	R.W.T
I	WAS DEFO. ADDED AND DRD PMA 35	R.W.T
J	WAS DEFO. ADDED AND DRD PMA 35	R.W.T
K	WAS DEFO. ADDED AND DRD PMA 35	R.W.T
L	WAS DEFO. ADDED AND DRD PMA 35	R.W.T
M	WAS DEFO. ADDED AND DRD PMA 35	R.W.T
N	WAS DEFO. ADDED AND DRD PMA 35	R.W.T
O	WAS DEFO. ADDED AND DRD PMA 35	R.W.T
P	WAS DEFO. ADDED AND DRD PMA 35	R.W.T
Q	WAS DEFO. ADDED AND DRD PMA 35	R.W.T
R	WAS DEFO. ADDED AND DRD PMA 35	R.W.T
S	WAS DEFO. ADDED AND DRD PMA 35	R.W.T
T	WAS DEFO. ADDED AND DRD PMA 35	R.W.T
U	WAS DEFO. ADDED AND DRD PMA 35	R.W.T
V	WAS DEFO. ADDED AND DRD PMA 35	R.W.T
W	WAS DEFO. ADDED AND DRD PMA 35	R.W.T
X	WAS DEFO. ADDED AND DRD PMA 35	R.W.T
Y	WAS DEFO. ADDED AND DRD PMA 35	R.W.T
Z	WAS DEFO. ADDED AND DRD PMA 35	R.W.T

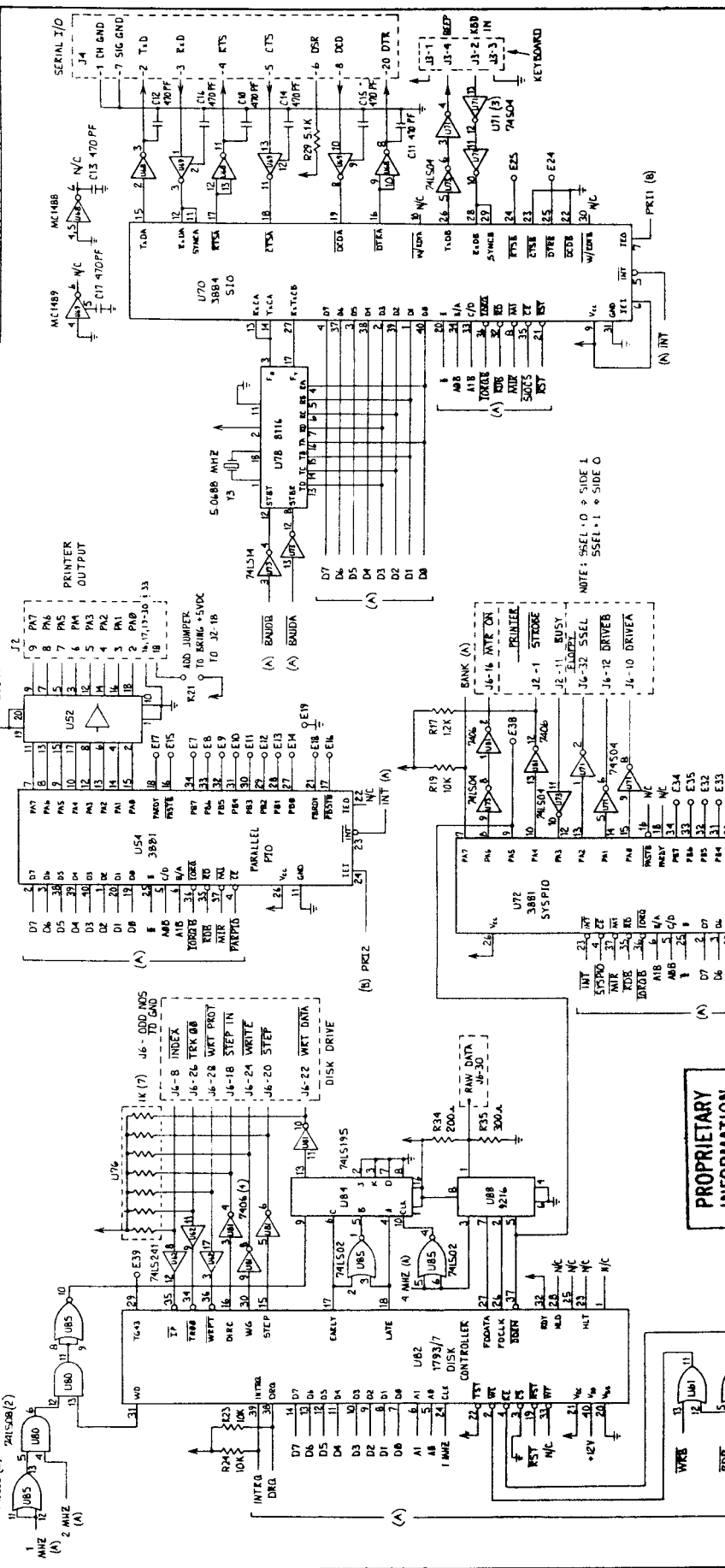

QTY	PART OR IDENTIFYING NO.	NOMENCLATURE OR DESCRIPTION	U.S. CODE	CREDIT ITEM NO.
1	74LS241	HEX INVERTER	74LS241	
1	74LS04	INVERTER	74LS04	
1	74LS00	NAND GATE	74LS00	
1	74LS02	NOR GATE	74LS02	
1	74LS03	3-STATE BUFFER	74LS03	
1	74LS05	INVERTER	74LS05	
1	74LS06	INVERTER	74LS06	
1	74LS07	INVERTER	74LS07	
1	74LS08	AND GATE	74LS08	
1	74LS09	AND GATE	74LS09	
1	74LS10	AND GATE	74LS10	
1	74LS11	AND GATE	74LS11	
1	74LS12	AND GATE	74LS12	
1	74LS13	AND GATE	74LS13	
1	74LS14	AND GATE	74LS14	
1	74LS15	AND GATE	74LS15	
1	74LS16	AND GATE	74LS16	
1	74LS17	AND GATE	74LS17	
1	74LS18	AND GATE	74LS18	
1	74LS19	AND GATE	74LS19	
1	74LS20	AND GATE	74LS20	
1	74LS21	AND GATE	74LS21	
1	74LS22	AND GATE	74LS22	
1	74LS23	AND GATE	74LS23	
1	74LS24	AND GATE	74LS24	
1	74LS25	AND GATE	74LS25	
1	74LS26	AND GATE	74LS26	
1	74LS27	AND GATE	74LS27	
1	74LS28	AND GATE	74LS28	
1	74LS29	AND GATE	74LS29	
1	74LS30	AND GATE	74LS30	
1	74LS31	AND GATE	74LS31	
1	74LS32	AND GATE	74LS32	
1	74LS33	AND GATE	74LS33	
1	74LS34	AND GATE	74LS34	
1	74LS35	AND GATE	74LS35	
1	74LS36	AND GATE	74LS36	
1	74LS37	AND GATE	74LS37	
1	74LS38	AND GATE	74LS38	
1	74LS39	AND GATE	74LS39	
1	74LS40	AND GATE	74LS40	
1	74LS41	AND GATE	74LS41	
1	74LS42	AND GATE	74LS42	
1	74LS43	AND GATE	74LS43	
1	74LS44	AND GATE	74LS44	
1	74LS45	AND GATE	74LS45	
1	74LS46	AND GATE	74LS46	
1	74LS47	AND GATE	74LS47	
1	74LS48	AND GATE	74LS48	
1	74LS49	AND GATE	74LS49	
1	74LS50	AND GATE	74LS50	
1	74LS51	AND GATE	74LS51	
1	74LS52	AND GATE	74LS52	
1	74LS53	AND GATE	74LS53	
1	74LS54	AND GATE	74LS54	
1	74LS55	AND GATE	74LS55	
1	74LS56	AND GATE	74LS56	
1	74LS57	AND GATE	74LS57	
1	74LS58	AND GATE	74LS58	
1	74LS59	AND GATE	74LS59	
1	74LS60	AND GATE	74LS60	
1	74LS61	AND GATE	74LS61	
1	74LS62	AND GATE	74LS62	
1	74LS63	AND GATE	74LS63	
1	74LS64	AND GATE	74LS64	
1	74LS65	AND GATE	74LS65	
1	74LS66	AND GATE	74LS66	
1	74LS67	AND GATE	74LS67	
1	74LS68	AND GATE	74LS68	
1	74LS69	AND GATE	74LS69	
1	74LS70	AND GATE	74LS70	
1	74LS71	AND GATE	74LS71	
1	74LS72	AND GATE	74LS72	
1	74LS73	AND GATE	74LS73	
1	74LS74	AND GATE	74LS74	
1	74LS75	AND GATE	74LS75	
1	74LS76	AND GATE	74LS76	
1	74LS77	AND GATE	74LS77	
1	74LS78	AND GATE	74LS78	
1	74LS79	AND GATE	74LS79	
1	74LS80	AND GATE	74LS80	
1	74LS81	AND GATE	74LS81	
1	74LS82	AND GATE	74LS82	
1	74LS83	AND GATE	74LS83	
1	74LS84	AND GATE	74LS84	
1	74LS85	AND GATE	74LS85	
1	74LS86	AND GATE	74LS86	
1	74LS87	AND GATE	74LS87	
1	74LS88	AND GATE	74LS88	
1	74LS89	AND GATE	74LS89	
1	74LS90	AND GATE	74LS90	
1	74LS91	AND GATE	74LS91	
1	74LS92	AND GATE	74LS92	
1	74LS93	AND GATE	74LS93	
1	74LS94	AND GATE	74LS94	
1	74LS95	AND GATE	74LS95	
1	74LS96	AND GATE	74LS96	
1	74LS97	AND GATE	74LS97	
1	74LS98	AND GATE	74LS98	
1	74LS99	AND GATE	74LS99	
1	74LS100	AND GATE	74LS100	

QTY	PART OR IDENTIFYING NO.	NOMENCLATURE OR DESCRIPTION	U.S. CODE	CREDIT ITEM NO.
1	74LS241	HEX INVERTER	74LS241	
1	74LS04	INVERTER	74LS04	
1	74LS00	NAND GATE	74LS00	
1	74LS02	NOR GATE	74LS02	
1	74LS03	3-STATE BUFFER	74LS03	
1	74LS05	INVERTER	74LS05	
1	74LS06	INVERTER	74LS06	
1	74LS07	INVERTER	74LS07	
1	74LS08	AND GATE	74LS08	
1	74LS09	AND GATE	74LS09	
1	74LS10	AND GATE	74LS10	
1	74LS11	AND GATE	74LS11	
1	74LS12	AND GATE	74LS12	
1	74LS13	AND GATE	74LS13	
1	74LS14	AND GATE	74LS14	
1	74LS15	AND GATE	74LS15	
1	74LS16	AND GATE	74LS16	
1	74LS17	AND GATE	74LS17	
1	74LS18	AND GATE	74LS18	
1	74LS19	AND GATE	74LS19	
1	74LS20	AND GATE	74LS20	
1	74LS21	AND GATE	74LS21	
1	74LS22	AND GATE	74LS22	
1	74LS23	AND GATE	74LS23	
1	74LS24	AND GATE	74LS24	
1	74LS25	AND GATE	74LS25	
1	74LS26	AND GATE	74LS26	
1	74LS27	AND GATE	74LS27	
1	74LS28	AND GATE	74LS28	
1	74LS29	AND GATE	74LS29	
1	74LS30	AND GATE	74LS30	
1	74LS31	AND GATE	74LS31	
1	74LS32	AND GATE	74LS32	
1	74LS33	AND GATE	74LS33	
1	74LS34	AND GATE	74LS34	
1	74LS35	AND GATE	74LS35	
1	74LS36	AND GATE	74LS36	
1	74LS37	AND GATE	74LS37	
1	74LS38	AND GATE	74LS38	
1	74LS39	AND GATE	74LS39	
1	74LS40	AND GATE	74LS40	
1	74LS41	AND GATE	74LS41	
1	74LS42	AND GATE	74LS42	
1	74LS43	AND GATE	74LS43	
1	74LS44	AND GATE	74LS44	
1	74LS45	AND GATE	74LS45	
1	74LS46	AND GATE	74LS46	
1	74LS47	AND GATE	74LS47	
1	74LS48	AND GATE	74LS48	
1	74LS49	AND GATE	74LS49	
1	74LS50	AND GATE	74LS50	
1	74LS51	AND GATE	74LS51	
1	74LS52	AND GATE	74LS52	
1	74LS53	AND GATE	74LS53	
1	74LS54	AND GATE	74LS54	
1	74LS55	AND GATE	74LS55	
1	74LS56	AND GATE	74LS56	
1	74LS57	AND GATE	74LS57	
1	74LS58	AND GATE	74LS58	
1	74LS59	AND GATE	74LS59	
1	74LS60	AND GATE	74LS60	
1	74LS61	AND GATE	74LS61	
1	74LS62	AND GATE	74LS62	
1	74LS63	AND GATE	74LS63	
1	74LS64	AND GATE	74LS64	
1	74LS65	AND GATE	74LS65	
1	74LS66	AND GATE	74LS66	
1	74LS67	AND GATE	74LS67	
1	74LS68	AND GATE	74LS68	
1	74LS69	AND GATE	74LS69	
1	74LS70	AND GATE	74LS70	
1	74LS71	AND GATE	74LS71	
1	74LS72	AND GATE	74LS72	
1	74LS73	AND GATE	74LS73	
1	74LS74	AND GATE	74LS74	
1	74LS75	AND GATE	74LS75	
1	74LS76	AND GATE	74LS76	
1	74LS77	AND GATE	74LS77	
1	74LS78	AND GATE	74LS78	
1	74LS79	AND GATE	74LS79	
1	74LS80	AND GATE	74LS80	
1	74LS81	AND GATE	74LS81	
1	74LS82	AND GATE	74LS82	
1	74LS83	AND GATE	74LS83	
1	74LS84	AND GATE	74LS84	
1	74LS85	AND GATE	74LS85	
1	74LS86	AND GATE	74LS86	
1	74LS87	AND GATE	74LS87	
1	74LS88	AND GATE	74LS88	
1	74LS89	AND GATE	74LS89	
1	74LS90	AND GATE	74LS90	
1	74LS91	AND GATE	74LS91	
1	74LS92	AND GATE	74LS92	
1	74LS93	AND GATE	74LS93	
1	74LS94	AND GATE	74LS94	
1	74LS95	AND GATE	74LS95	
1	74LS96	AND GATE	74LS96	
1	74LS97	AND GATE	74LS97	
1	74LS98	AND GATE	74LS98	
1	74LS99	AND GATE	74LS99	
1	74LS100	AND GATE	74LS100	

PROPRIETARY INFORMATION
Not for distribution or transmission to any other person or organization by company without the permission of Kierpa Corporation.

6.3 KAYPRO 10 MAINBOARD (81-180-n)

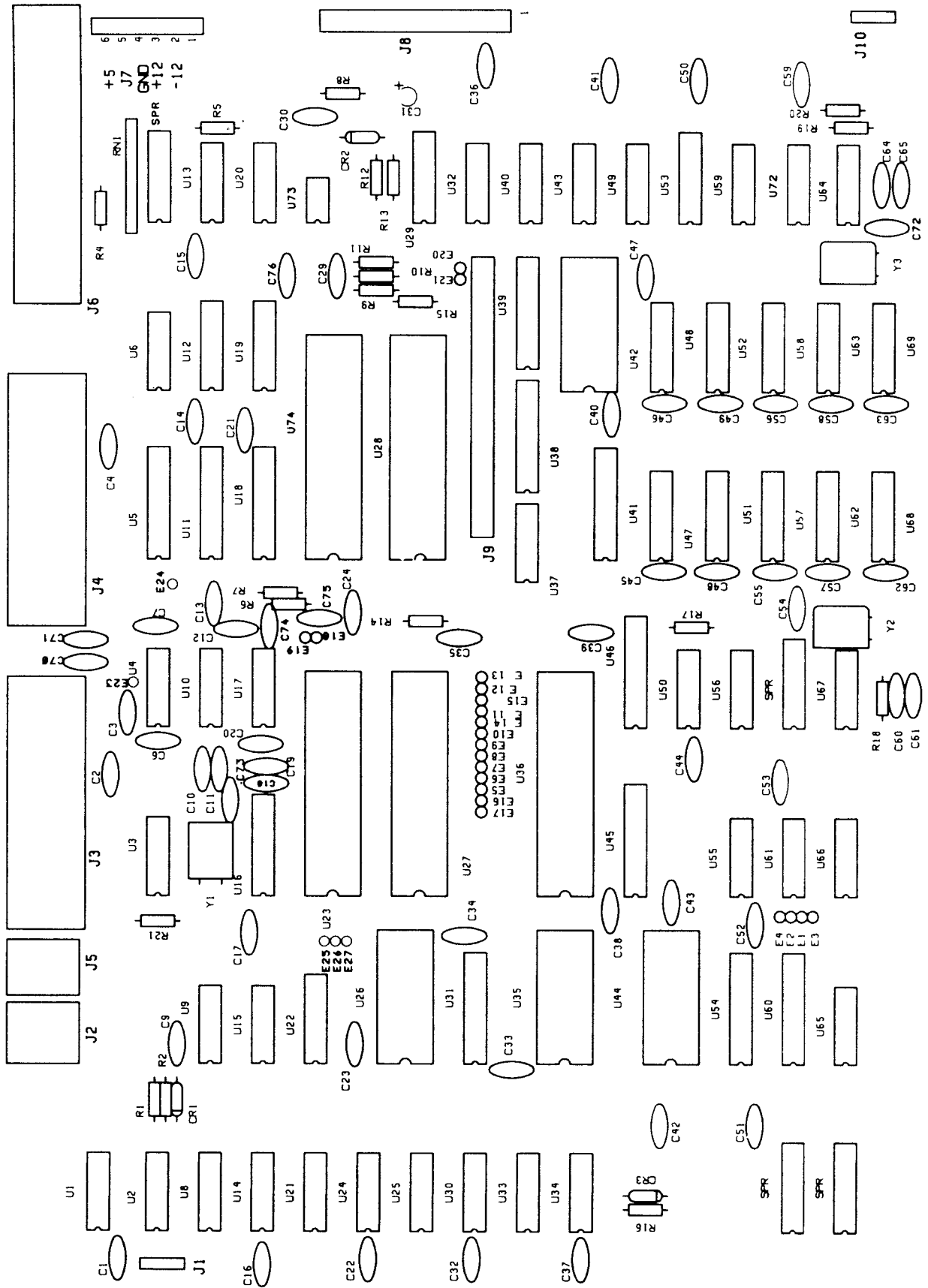

PC 81-180 C

IC LIST, 81-180-n

Reference Designation		Description
U1	74S74	Dual "D" flip-flop
U2	74S08	Hex Schmitt Quad AND gate
U3	74S04	Hex inverter
U4, U10	1489	Quad SCHMITT line receiver
U5, U38, U41	74LS244	Octal buffer
U6, U21, U24, U33, U49	74LS74	Dual "D" flip-flop
U20, U30	74LS08	Quad AND gate
U8, U37, U50	74LS00	Quad NAND gate
U9, U59	74LS393	Dual binary counter
U11, U18, U31, U45, U46, U60	74LS373	Octal "D" latch
U12, U19	74LS138	3/8 MUX
U13	7406	Hex inverter, open collector
U14	74S86	Hex Schmitt Quad XOR gate
U15, U61	74S20	Dual NAND gate
U16	8116	Dual programmable baud rate generator
U17	1488	Quad transmitter
U22	74LS165	8-bit shift register
U23, U27	Z80A SIO	
U25, U72	74LS10	Tri NAND gate
U26	81-187	Character generator EPROM (2732)
U28	Z80A CPU	
U29	74LS195	4-bit shift register
U32, U43	74LS02	Quad NOR gate
U34	74LS14	Hex Schmitt inverter
U35, U44	6116	RAM, 2K x 8-bit (200ns)
U36	6545A-1	Video controller
U39, U54	74LS245	Bi-directional 8-bit buffer
U42	81-302-C	Boot EPROM (2732)
U40	74LS32	Quad OR gate
U47, U48	74LS157	Quad 2/1 MUX
U51, U52, U57, U58, U62, U63, U68, U69	4565N-15	Dynamic RAM 64K x 1 (150ns) (Mostek number)
U53	74LS163	Synchronous 4-bit binary counter
U55	14-2-392	14-Pin pull-up resistor
U56, U65	74LS04	Hex inverter
U64, U67	74HC04	Hex inverter, CMOS
U66	74LS93	Asynchronous 4-bit binary counter
U73	WD9216	Data separator
U74	1793	Floppy disk controller

SCOPE SIGNALS FOR TROUBLESHOOTING 81-180-n

The examples of correct signals shown here do not represent all of the signals on the 81-180-n mainboard, since most of the signals will be high-low toggles. A group of signals taken from a video clock divider (U66) are shown to illustrate the timing relationships between the various video signals.

The signal measurements were made using a Tektronix oscilloscope, model 2213. It has a bandwidth of DC-60 MHz, sensitivity of 2mV/cm, a sweep delay of 0.1 microseconds to 1 second, and a graticule display measuring 8 x 10 cm.

Each square of the representation is the equivalent of one square cm. on the graticule. The scope was set for 2V/div. and .2micro-secs/div. for all figures except figure 2, which was set at .5micro-secs/div.

Signal M1 from pin 27 of the CPU (U28) was triggered on. This signal is shown in the top half of each display and was channel 1. Ground for signals shown on channel 2 was established at the first graticule line above the bottom of the display.

State of the machine: The machine has just booted-up on the hard drive.

Figure 1: Pin 6 of U28, 4MHz clock signal.

Figure 2: Pin 24 of U74, 1MHz clock signal.

Figure 3: Pin 12 of U66, video, clock divider.

Figure 4: Pin 9 of U66, video, clock divider.

Figure 5: Pin 8 of U66, video, clock divider.

Figure 6: Pin 11 of U66, video, clock divider.

FIGURE 1

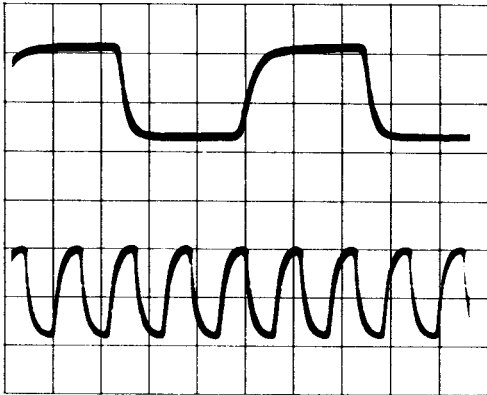

FIGURE 2

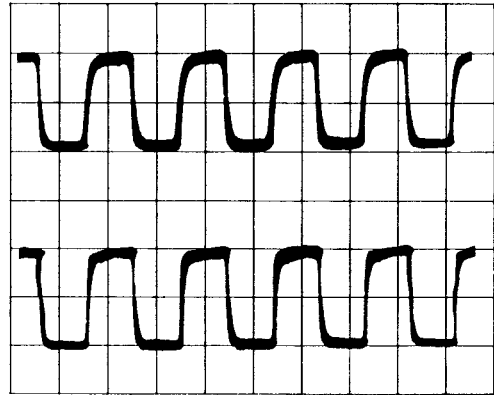

FIGURE 3

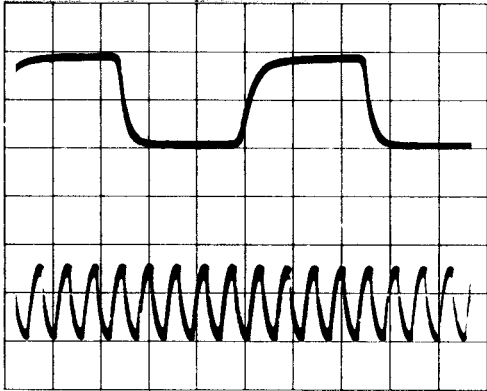

FIGURE 4

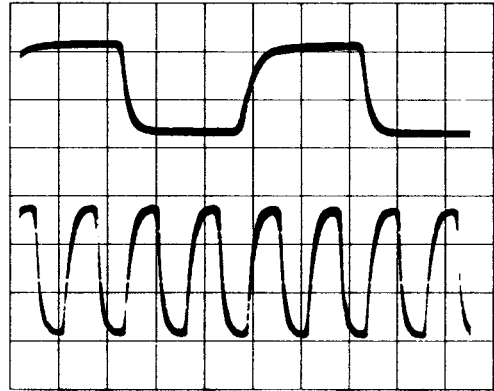

FIGURE 5

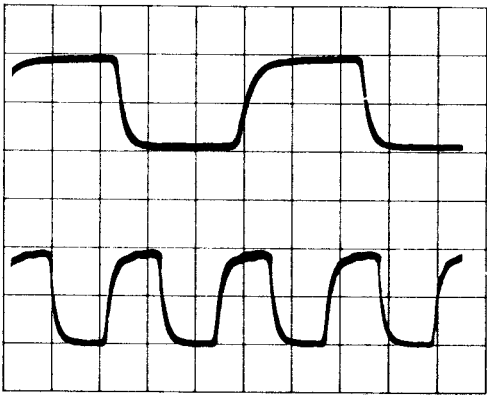
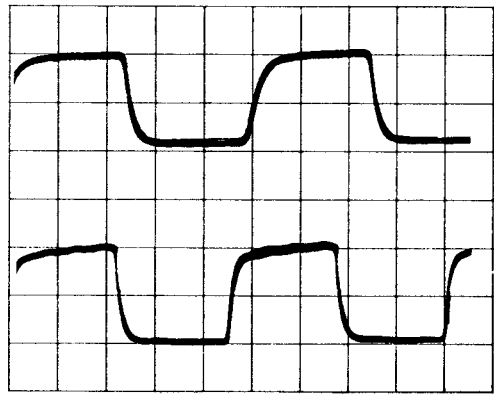
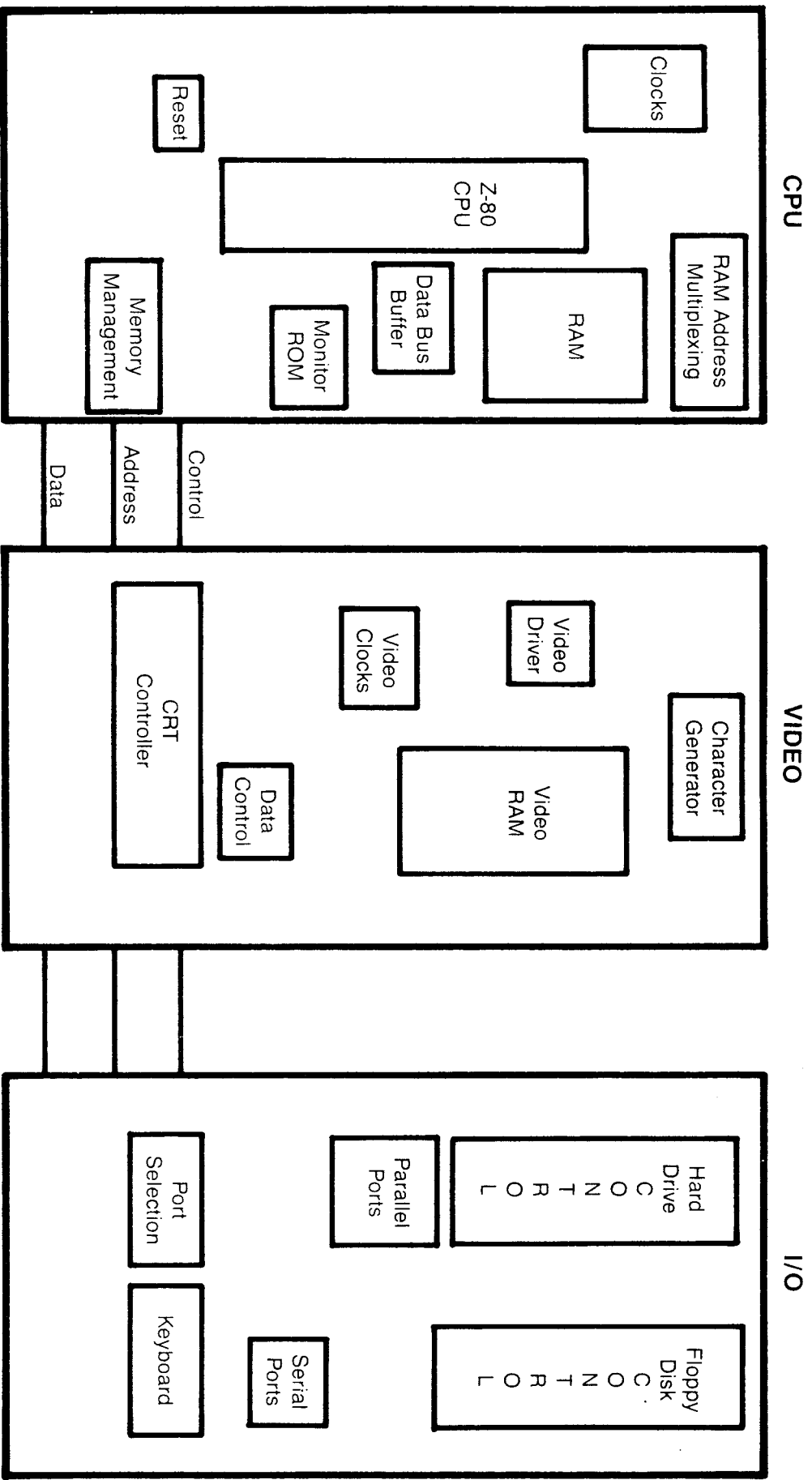

FIGURE 6





KAYPRO 10 BLOCK DIAGRAM

6.4 KAYPRO 2/84 AND 2X (81-294-n)

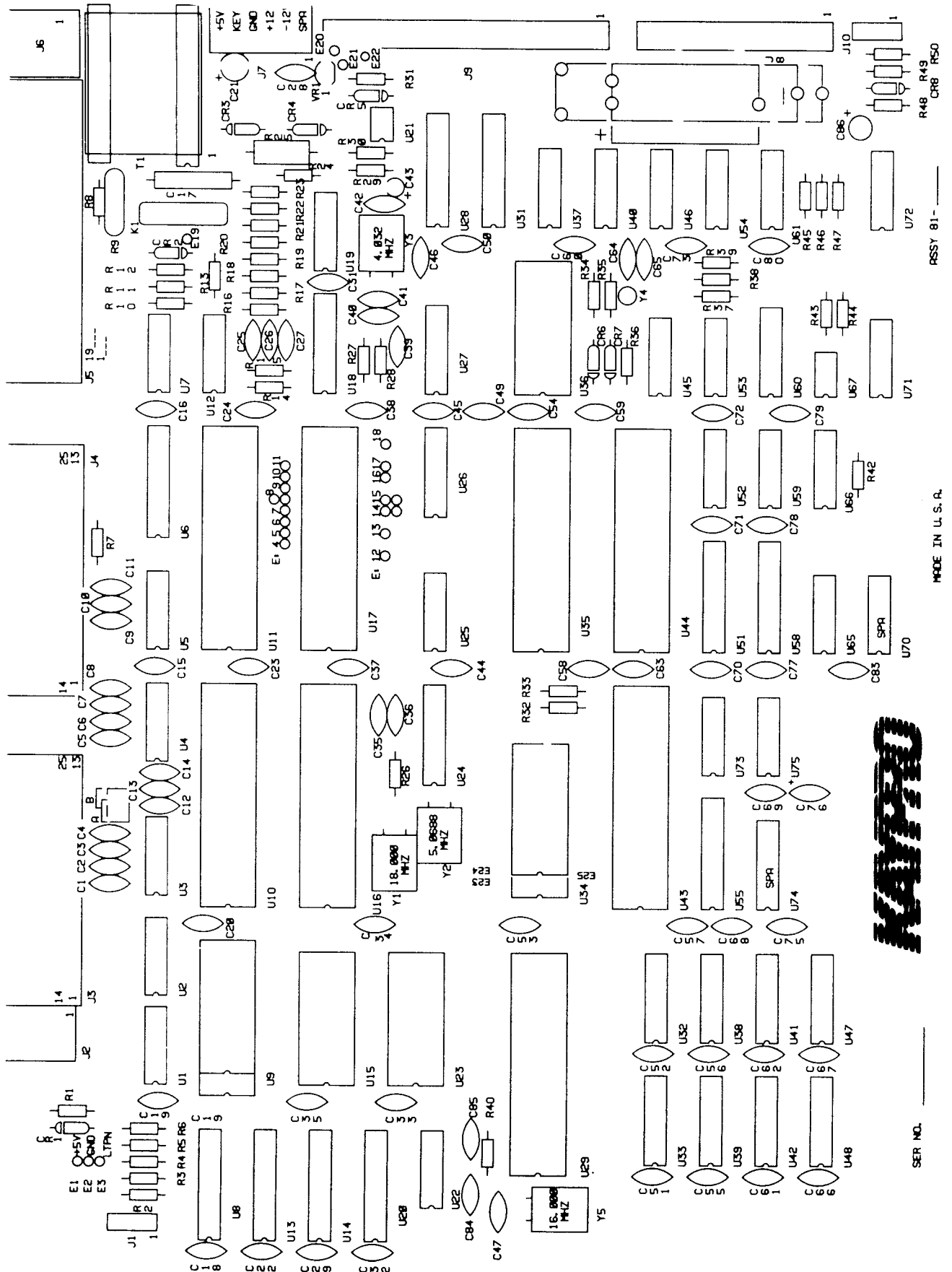

ASSEMBLY 81-294-n

MADE IN U.S.A.



SER. NO.

IC LIST, 81-294-n

Reference Designation		Description
U1, U54	7406	Hex inverter, open collector
U2, U25, U71	74LS14	Hex Schmitt inverter
U3, U5	1489	Quad Schmitt line driver
U4	1488	Quad line driver
U6, U13, U14, U55, U58	74LS373	Octal "D" latch
U8	74LS374	Octal "D" flip-flop
U9	81-235-n	Character PROM (2732)
U10	81-189	Custom gate array
U11, U17	Z80 SIO	
U15, U23	6116	Video RAM
U16	6545EA	CRT controller
U20, U31	74LS245	Octal bus transceiver
U22	3.9K	Pull-up Resistor
U24	WD1943/ 8116	Dual programmable baud rate generator
U26, U27	74LS138	3/8 MUX
U28, U51	74LS244	Octal buffer/line driver (3-state outputs)
U29	81-194	Custom gate array
U32, U33, U38, U39, U41, U42, U47, U48	2164	64K x 1 RAM
U34	81-292	Boot PROM (2764)
U37, U45, U59, U72	74LS02	Quad NOR gate
U40	74LS00	Quad NAND gate
U43	Z80A CPU	
U44	1793	Floppy disk controller
U46	74LS04	Hex inverter
U52	74LS32	Quad OR gate
U60	74LS195	4-bit shift register
U61	74LS08	Quad AND gate
U65	74LS10	Tri NAND gate
U66, U75	74LS74	Dual "D" flip-flop
U67	FDC9216	Data separator
U73	74HC00	Quad NAND gate

SCOPE SIGNALS, 81-294-n

Scope signals for this mainboard will be available soon; the section will be sent to the dealers for insertion into the new Technical Reference Manual as soon as it is available.

REVISIONS		DATE	APPROVED
ZONE	LTR. EFFECT.	DESCRIPTION	

U NOS. USED: 23, 45, 11
17, 24, 25

J4:
SERIAL
DATA CHANNEL

J4 PINS N/C: 9-14, 16, 19, 21-25

PROPRIETARY INFORMATION
Not for distribution or transmission to any other person or organization or company without the permission of Kaypro Corporation

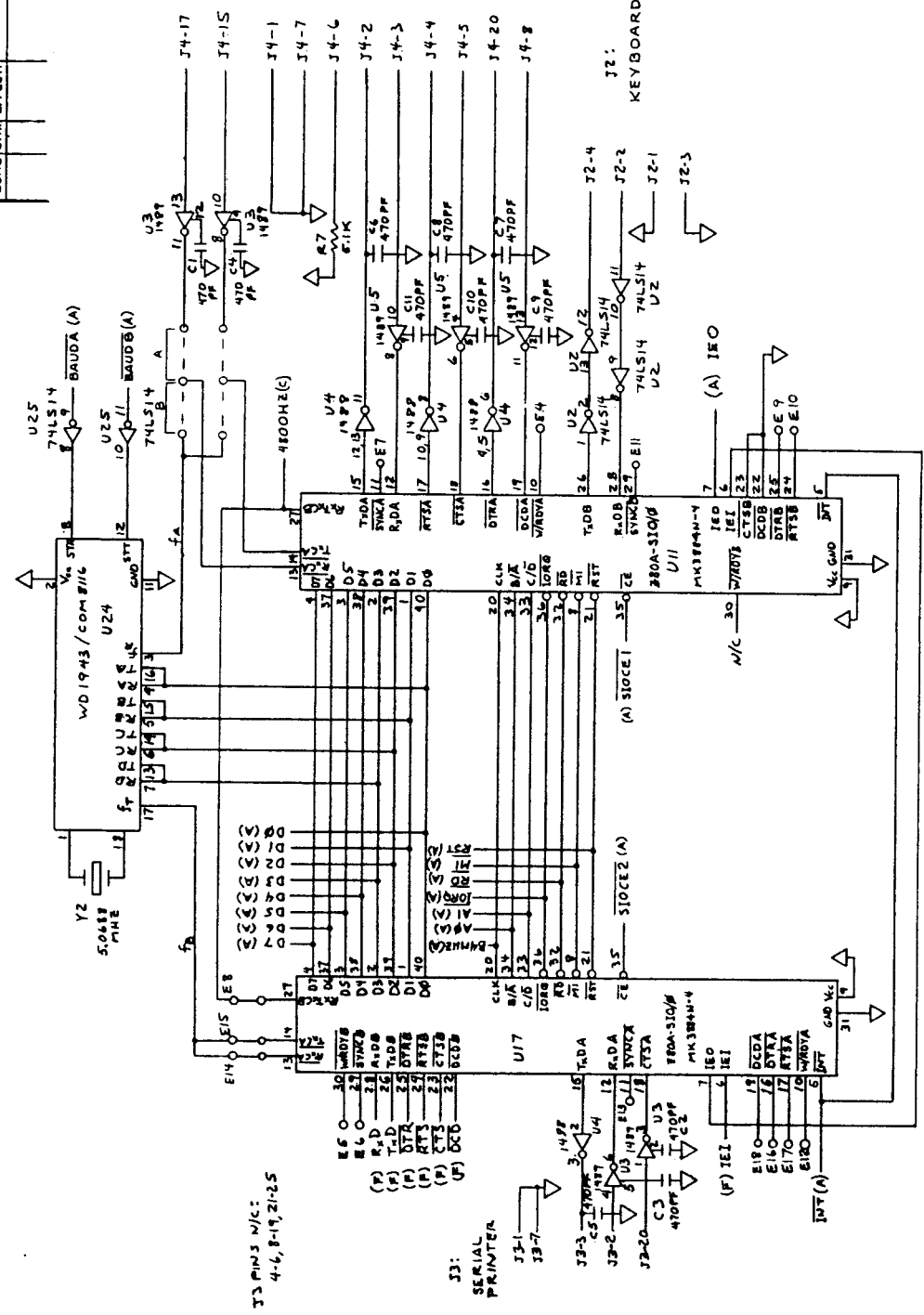

QTY REQD	PART OR IDENTIFYING NO.	NONENCLATURE OR DESCRIPTION	MFR CODE	CIRCUIT REF.	ITEM NO.

UNLESS OTHERWISE SPECIFIED		CONTR. NO.	
DIMENSIONS ARE IN INCHES	DRAWN	2-24-77	
TOLERANCES ON DECIMALS	CHECK		
ANGLES ±0°30'	APPR	2-1-77	
FRACTIONS ±1/32	RELEASE DATE	3-6-87	
MATERIAL	BOARD REV A		

APPLICATION	QTY.
NEXT ASST.	
FINAL ASST.	
NEXT FINAL ASST.	

PUR TO U4: +12V TO PIN 14
GND TO PIN 7
-12V TO PIN 1

NON-LINEAR SYSTEMS, INC.
DEL MAR, CALIFORNIA

SCHMATIC, SERIAL PORTS

KAYPRO 2184

SIZE CODE IDENT NO. **C 03626**

SCALE WEIGHT SHEET 2 E

REVISIONS		DATE	APPROVED
ZONE	LTR.	EFFECT.	DESCRIPTION

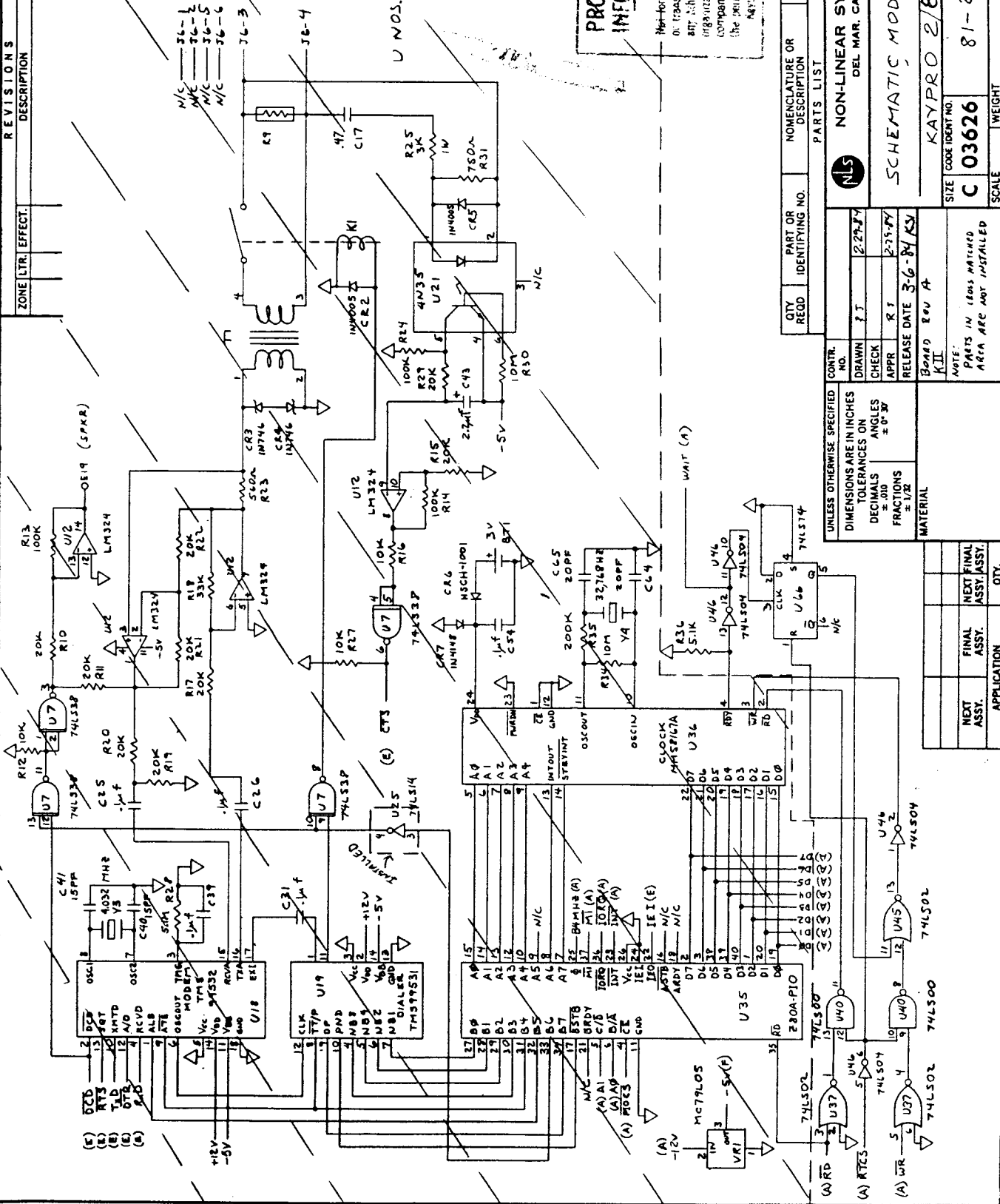

U NOS. USED: 7, 12, 18,
19, 21, 25, 35, 36,
37, 40, 45, 46,
66

PROPRIETARY INFORMATION
 Not for distribution
 or transmission to
 any other person
 organization or
 company without
 the permission of
 Agava Corporation

QTY REQD	PART OR IDENTIFYING NO.	NOMENCLATURE OR DESCRIPTION	MFR. CODE	CIRCUIT ITEM REF. NO.

UNLESS OTHERWISE SPECIFIED	
CONTR. NO.	CONT.

DIMENSIONS ARE IN INCHES	
TOLERANCES ON	ANGLES
DECIMALS ± .010	± 30°
FRACTIONS ± 1/32	

MATERIAL		APPLICATION		QTY.

NON-LINEAR SYSTEMS, INC.
 DEL MAR, CALIFORNIA

SCHMATIC MODEM & RTC

KAYPRO 2/84

SIZE CODE IDENT NO. **C 03626**

SCALE WEIGHT SHEET 2 F

6.5 KAYPRO 4/84 MAINBOARD (81-184-n)

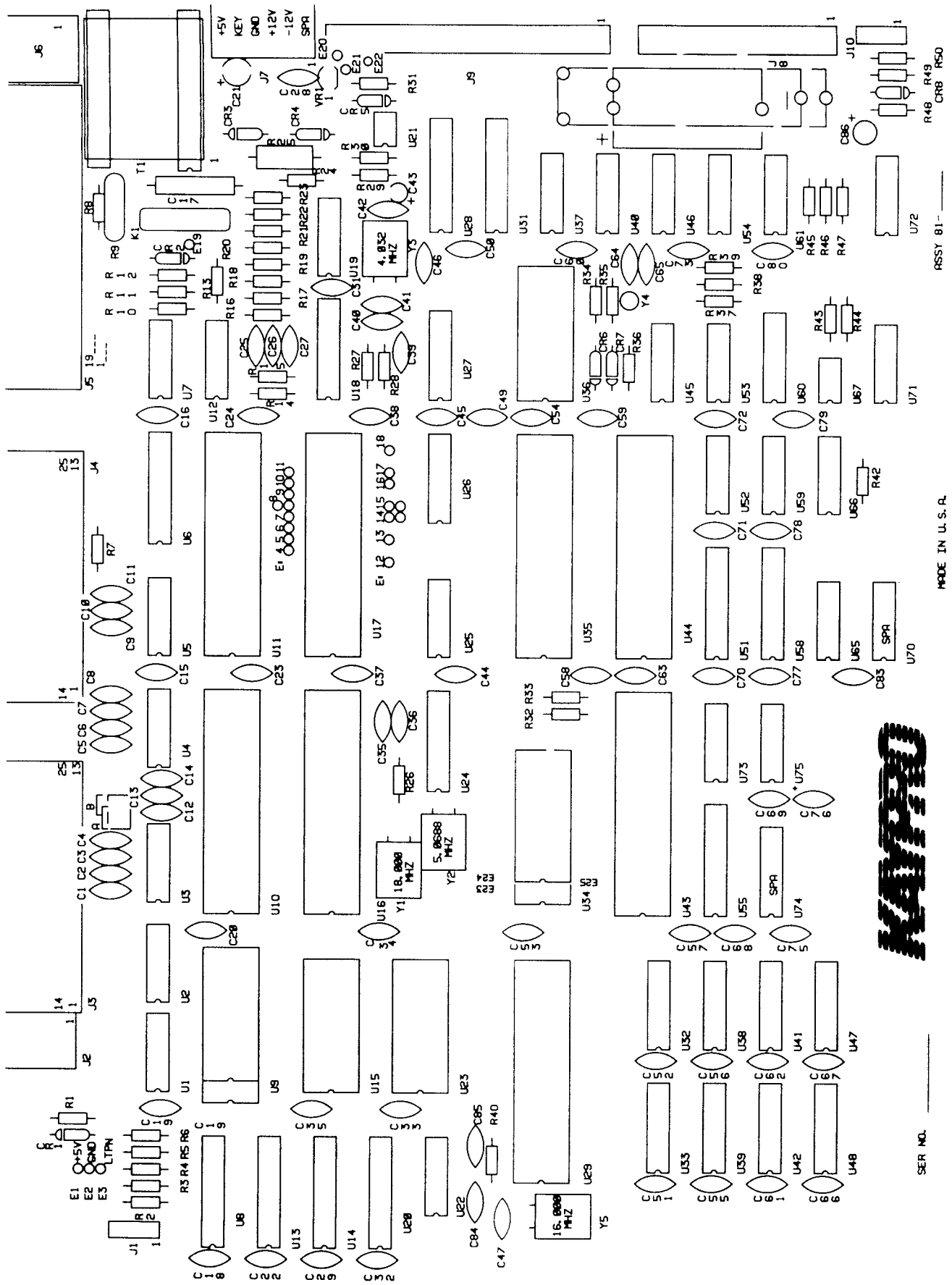

SER. NO.

MADE IN U.S.A.

ASSY 81-

IC LIST, 81-184-n

Reference Designation		Description
U1, U54	7406	Hex inverter, open collector
U2, U25, U71	74LS14	Hex Schmitt inverter
U3, U5	1489	Quad Schmitt line driver
U4	1488	Quad line driver
U6, U13, U14, U55, U58	74LS373	Octal "D" latch
U7	74LS38	Positive-NAND buffer
U8	74LS374	Octal "D" flip-flop
U9	81-235	Character PROM (2732)
U10	81-189	Custom gate array
U11, U17	Z80A SIO	
U12	LM324	Op-Amp
U15, U23	6116	Video RAM
U16	6545A	Video controller
U18	TMS 99532	Modem
U19	TMS 99531	Dialer
U20, U31	74LS245	Octal bus transceiver (3-state outputs)
U21	4N35	Photo isolator
U22	3.9K	Pullup resistor, 14-pin DIP
U24	WD1943/ 8116	Dual programmable baud rate generator
U26, U27	74LS138	3/8 MUX
U28, U51	74LS244	Octal buffer/line driver
U29	81-194	Custom gate array
U32, U33, U38, U39, U41, U42, U47, U48	2164	64K x 1 RAM
U34	81-292	Boot PROM (2764)
U35	Z80A PIO	
U36	MM581678	Clock
U37, U45, U59, U72	74LS02	Quad NOR gate
U40	74LS00	Quad NAND gate
U43	Z80A CPU	
U44	1793	Floppy disk controller
U46	74LS04	Hex inverter
U52	74LS32	Quad OR gate
U53, U70, U74, U75		Spares
U60	74LS195	4-bit shift register
U61	74LS08	Quad AND gate
U65	74LS10	Tri NAND gate
U66, U75	74LS74	Dual "D" flip-flop
U67	FDC9216	Data separator
U73	74HC00	Quad NAND gate

SCOPE SIGNALS, 81-184-n

Scope signals for this mainboard will be available soon; the section will be sent to the dealers for insertion into the new Technical Reference Manual as soon as it is available.

ZONE	LTR	EFFECT	DESCRIPTION	DATE APPROVED
A	10-23-79	RG WAS 2000C		11-18-79 R.W.J.
B	2-23-79	AS WAS 1000C, RC WAS 2000C		2-23-79 H.A.B.
C	4-14-79	ADDED U75 FOR VIDEO TIMING		4-14-79 H.A.B.
		ALL ORIGINAL NETWORK COMPONENTS		
		WAS INSPECTED, AND ALL PARTS		
		WERE FOUND TO BE IN COMPLIANCE WITH		
		REQUIREMENTS OF MIL-STD-883C		

UNOS. USED: 1, 2, 8, 9,
10, 13, 14, 15,
16, 20, 22, 23

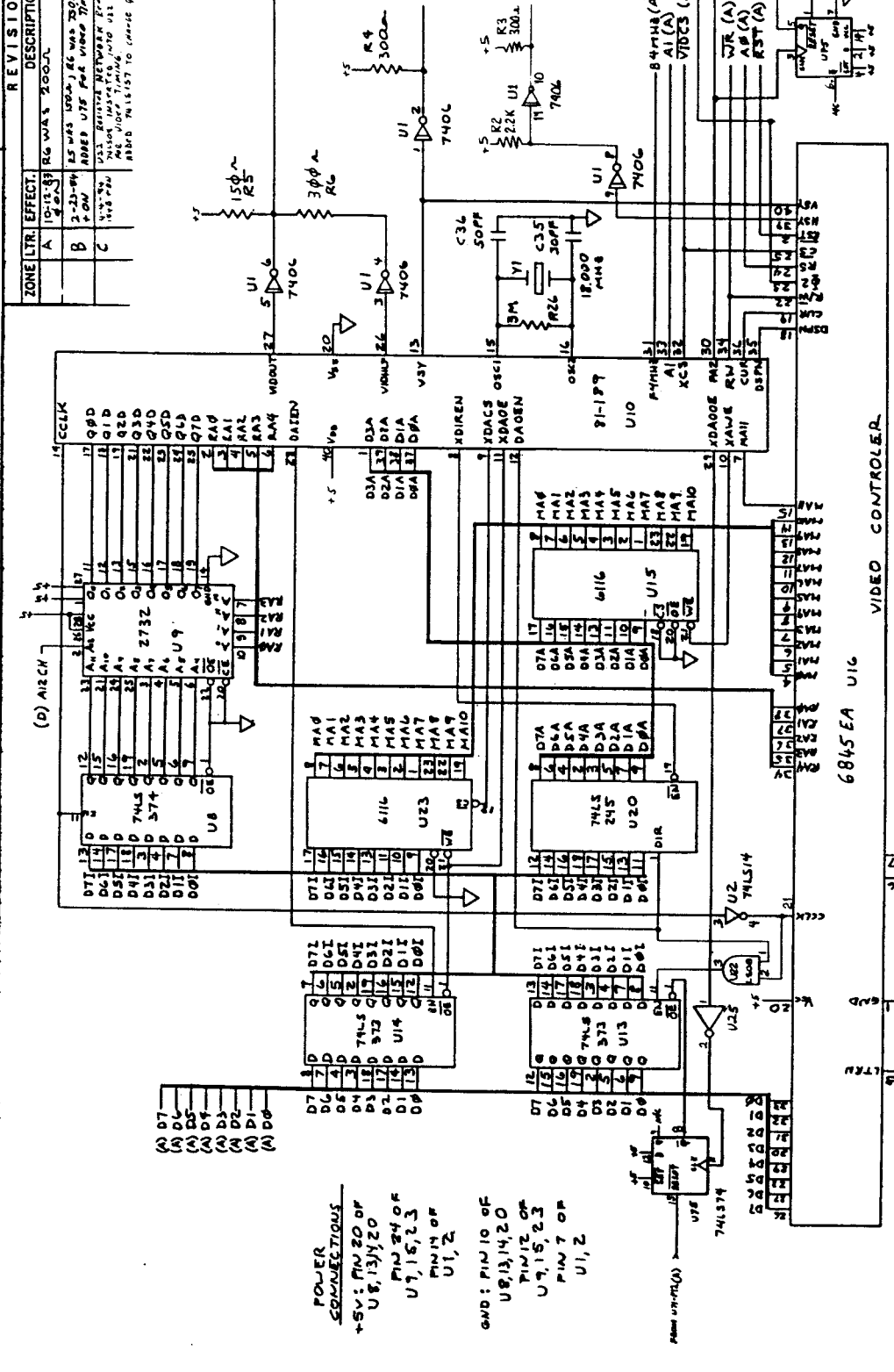

POWER CONNECTIONS
 +5V: PIN 20 OF U8, 13, 14, 20
 PIN 24 OF U7, 15, 23
 PIN 10 OF U1, 2
 GND: PIN 10 OF U8, 13, 14, 20
 PIN 12 OF U7, 15, 23
 PIN 7 OF U1, 2

QTY	RECD	PART OR IDENTIFYING NO.	NOMENCLATURE OR DESCRIPTION	MFR. CODE	CIRCUIT REF.	ITEM NO.
			NON-LINEAR SYSTEMS, INC.			
			DEL MAR, CALIFORNIA			
			SCHMATIC, VIDEO			
			KAYPRO 4/8A			
			SIZE CODE IDENT NO.			
			C 03626			
			SCALE			
			WEIGHT			
			SHEET			28

UNLESS OTHERWISE SPECIFIED	CONTR. NO.
DIMENSIONS ARE IN INCHES	
TOLERANCES ON DECIMALS	
ANGLES ±0°30'	
FRACTIONS ±1/32"	
MATERIAL	
BOARD REV 8	
(61-104)	
RELEASE DATE 9-20-83	
APPR	
CHECK	
DRAWN	
QTY	
RECD	
APPROVAL	
FINAL ASST.	
NEXT FINAL ASST.	
APPLICATION	
QTY	

PROPRIETARY INFORMATION
 Not for distribution in transmission to any other person or organization or the company without the permission of Raypro Corporation.

REVISIONS	
ZONE	DESCRIPTION

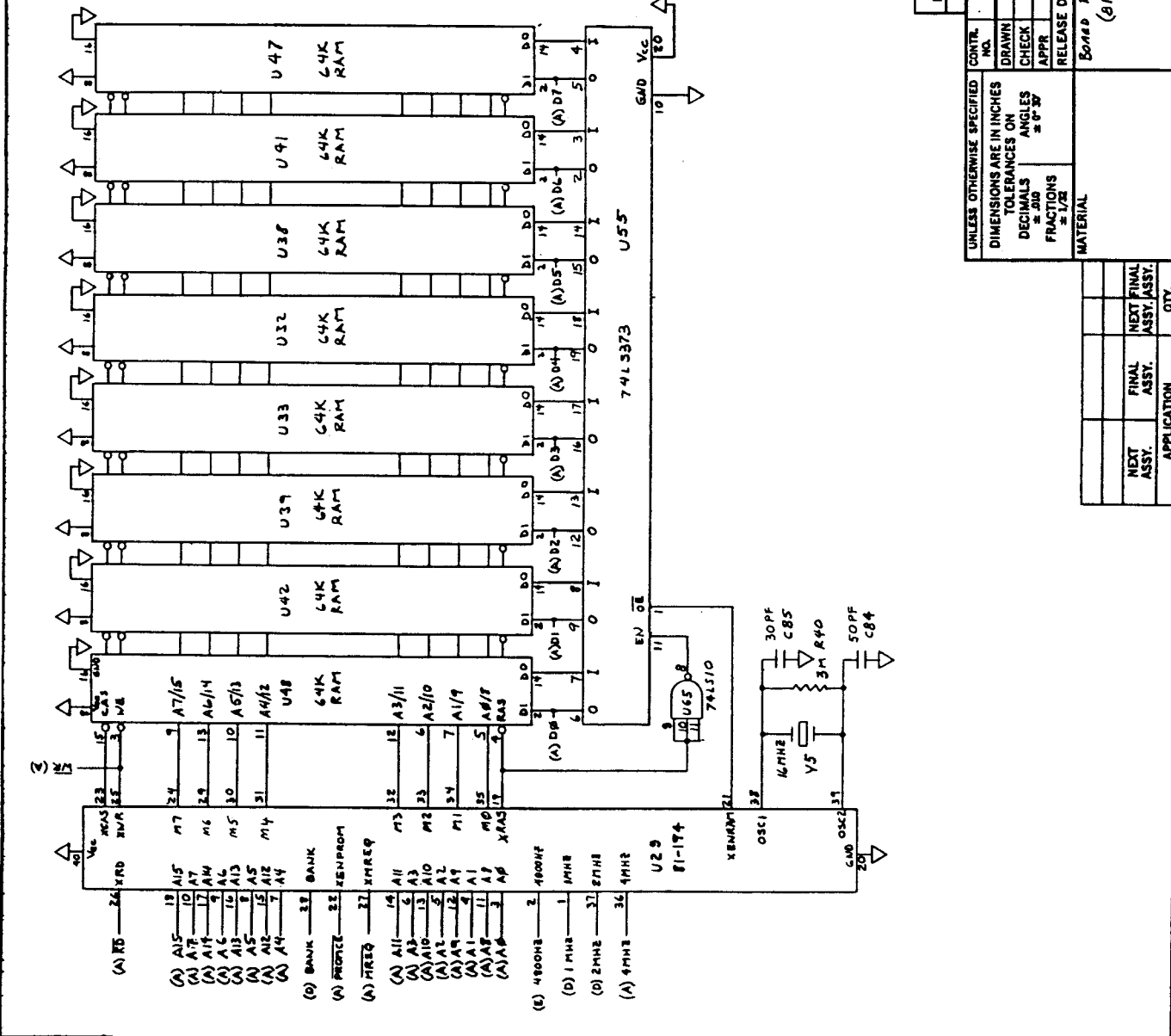

UNDS USED: 29, 48, 42,
39, 33, 32, 38, 41, 47, 55
65

PROPRIETARY INFORMATION
Not for distribution
Transmission to
any other person
organization or
company without
the permission of
Kaypro Corporation

QTY RECD	PART OR IDENTIFYING NO.	NOMENCLATURE OR DESCRIPTION	MFR. CODE	CIRCUIT REF.	ITEM NO.

PARTS LIST		NON-LINEAR SYSTEMS, INC.	
UNLESS OTHERWISE SPECIFIED DIMENSIONS ARE IN INCHES TOLERANCES ON DECIMALS ANGLES FRACTIONS		DEL MAR, CALIFORNIA	

CONTR. NO.	SCALE	WEIGHT	SHEET

REVISIONS					
ZONE	TR.	EFFECT.	DESCRIPTION	DATE	APPROVED
A	ALL		U60-10 WAS CONNECTED TO U67-3	1-17-77	RWT
B	ALL		WARRANTY: US-11, CHANGED TO US-11 DRIVE/TEC DRIVES INCLUDED	4-11-77	RAJ

UNOS. USED: 6, 4, 4, 5, 1, 5, 2, 5, 4, 5, 8,
5, 9, 10, 6, 1, 6, 5, 1, 6, 6
& 6, 7

JS: PARALLEL PRINTER

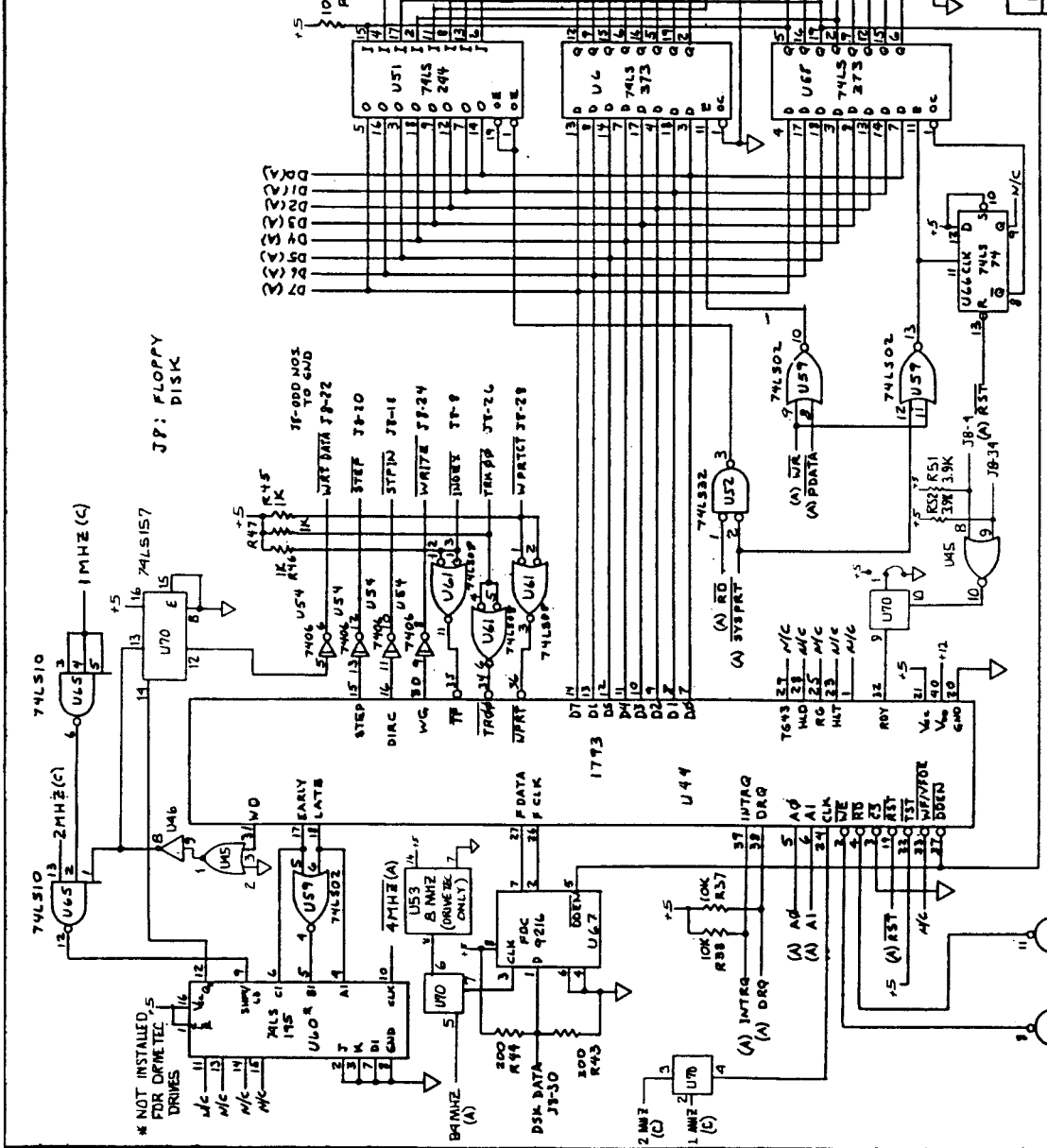

PARTS LIST	
QTY	IDENTIFYING NO.
	NON-DESCRIPTION OR NOMENCLATURE
	MFR. CODE
	CIRCUIT REF.
	ITEM NO.

UNLESS OTHERWISE SPECIFIED	
DIMENSIONS ARE IN INCHES	
TOLERANCES ON	
DECIMALS	ANGLES
±.010	±.030
FRACTIONS	FRACTIONS
± 1/32	± 1/32

CONTR. NO.	DRAWN	CHECK	APPR.	RELEASE DATE
	RJ		RWT	9-20-83

NON-LINEAR SYSTEMS, INC.
DIEL. MAR. CALIFORNIA

SCHMATIC, FLOPPY CONTROL
& PARALLEL PRINTER

KAYPRO 4/84

SIZE CODE IDENT. NO. **C 03626**

81-185

SCALE WEIGHT SHEET 20

PROPRIETARY INFORMATION

Not for distribution to other persons or organization or corporation without the permission of Kaypro Corporation

REVISIONS		DATE	APPROVED
ZONE	LTR.	EFFECT.	DESCRIPTION
A		1978	"B" JUMPS INSTALLED AND ADJ.
			WAB M.T.

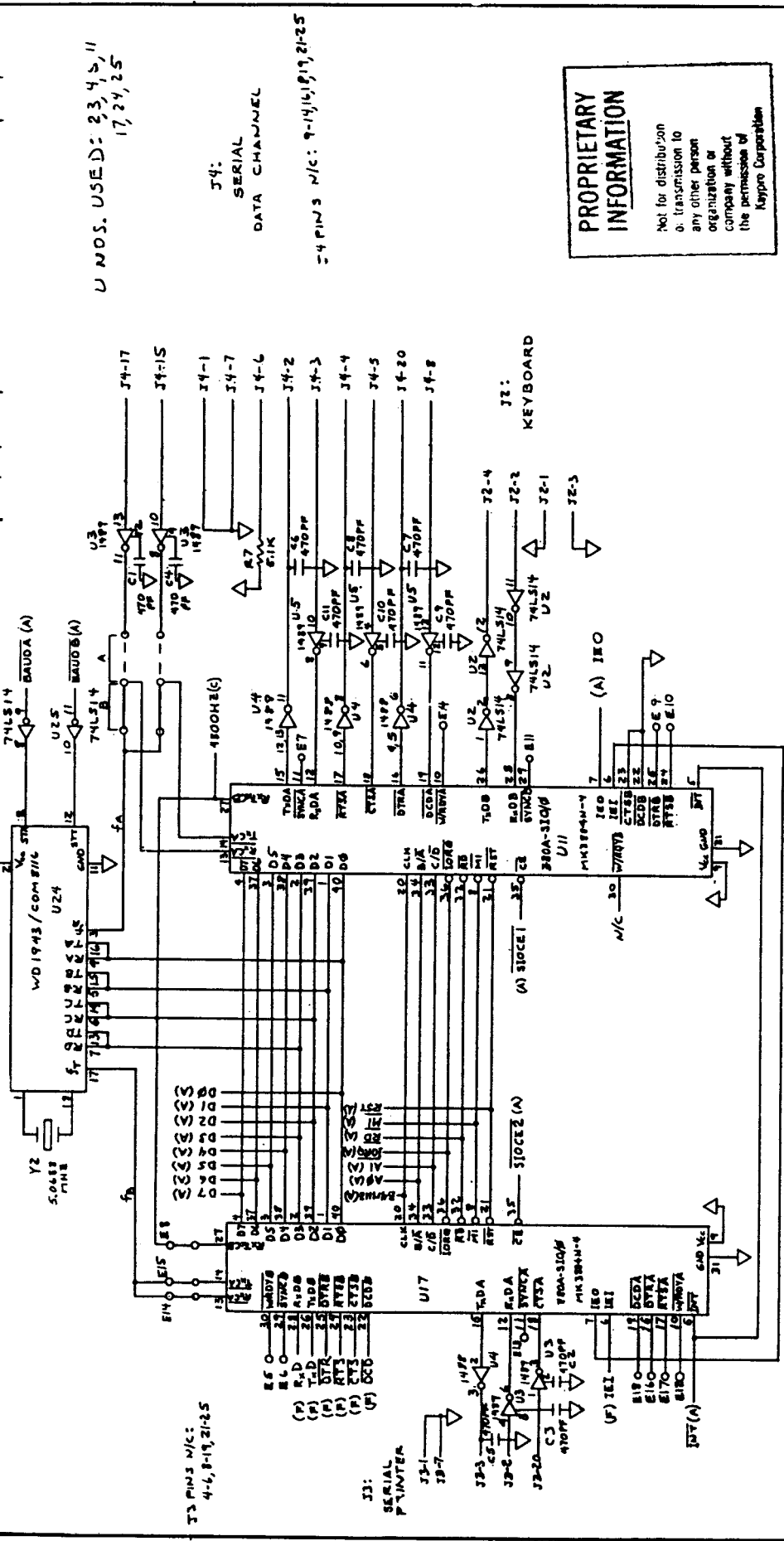

PROPRIETARY INFORMATION

Not for distribution to any other person or organization or company without the permission of Kaypro Corporation

QTY	RECD	PART OR IDENTIFYING NO.	NOMENCLATURE OR DESCRIPTION	MFR. CODE	CIRCUIT REF.	ITEM NO.
			NLS NON-LINEAR SYSTEMS, INC. DEL MAR, CALIFORNIA			
			SCHEMATIC, SERIAL PORTS			
			KAYPRO 4/84			
			SIZE CODE IDENT NO. C 03626			
			SCALE WEIGHT			
			91-185			
			SHEET 2 E			

UNLESS OTHERWISE SPECIFIED	CONTR. NO.
DIMENSIONS ARE IN INCHES	9-3-77
TOLERANCES ON ANGLES	
DECIMALS ± .010	
FRACTIONS ± 1/32	
MATERIAL	
	Revised Rev B (81-184)

APPLICATION	QTY.
NEXT ASSEMBLY	
FINAL ASSEMBLY	
NEXT ASSEMBLY	
FINAL ASSEMBLY	

PWR TO U4: +12V TO PIN 14
GND TO PIN 7
-12V TO PIN 1

ZONE	LTR.	EFFECT	DESCRIPTION	DATE	APPROVED
	B	1808	Changed value of C54 to 47uF Added 100K resistor in series with resistor R30, R31	4-20-79	JMB
	A	1804	CHANGED WAIT CIRCUIT	2-20-77	MEG AB

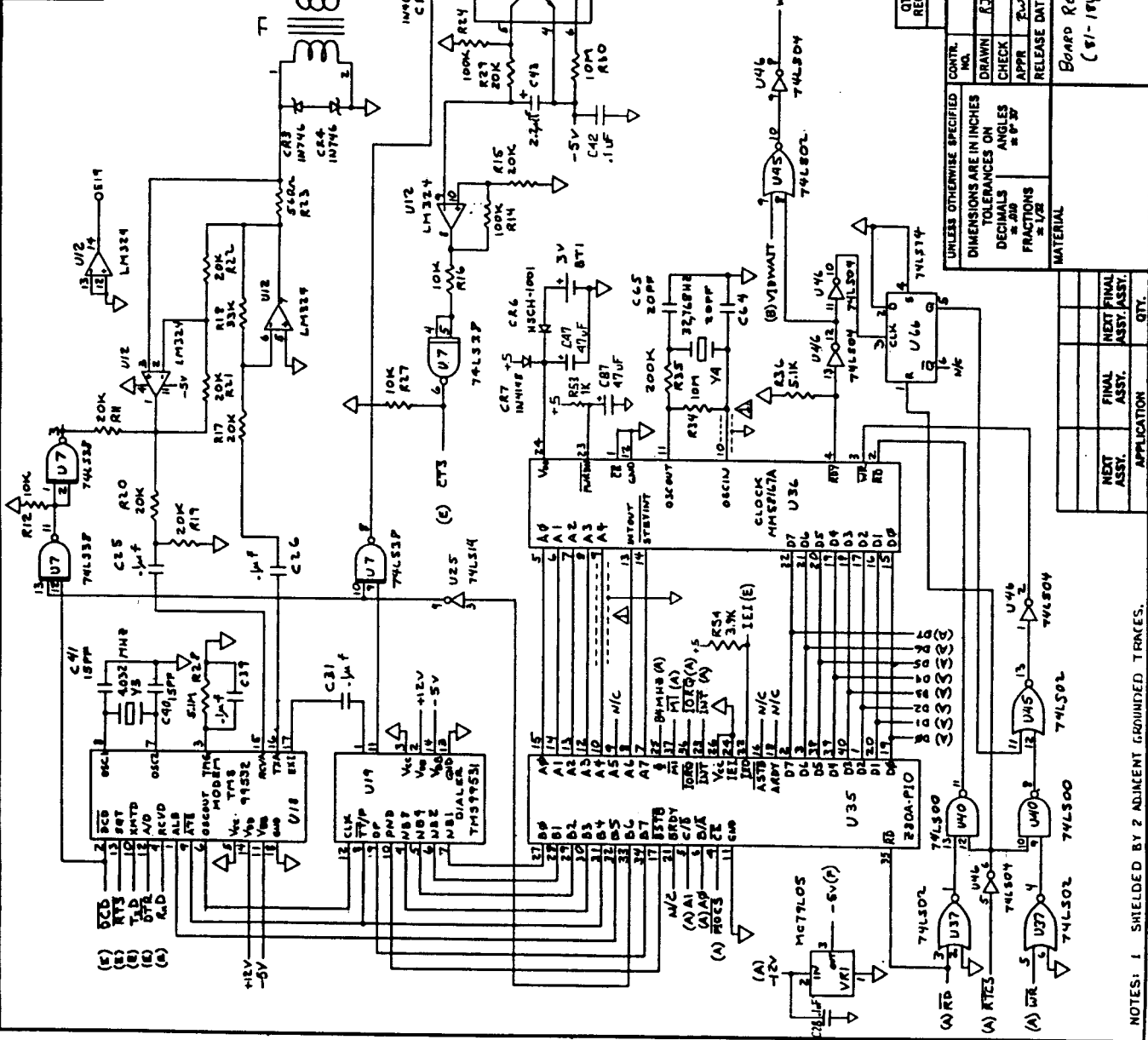

U NOS. USED: 7, 14, 18,
19, 21, 25, 35, 36,
37, 40, 45, 46,
66

PROPRIETARY INFORMATION
Not for distribution or transmission in any other person, organization or company without the permission of Raypro Corporation.

QTY	RECD	PART OR IDENTIFYING NO.	NOMENCLATURE OR DESCRIPTION	MFR. CODE	CIRCUIT REF.	ITEM NO.

UNLESS OTHERWISE SPECIFIED		DIMENSIONS ARE IN INCHES	
CONTR. NO.	1-2-83	TOLERANCES ON DECIMALS	±.010
DRAWN	RJ	TOLERANCES ON ANGLES	± 0° 30'
CHECK		FRACTIONS	± 1/32
APPR	EWJ	RELEASE DATE	4-20-79
MATERIAL			
BOARD REV B (81-194)			

APPLICATOR	QTY.

SIZE	CODE IDENT. NO.	SCALE	WEIGHT
C 03626			

NOTES: 1 SHIELDED BY 2 ADJACENT GROUNDED TRACES.

6.6 KAYPRO ROBIE (81-296-n)

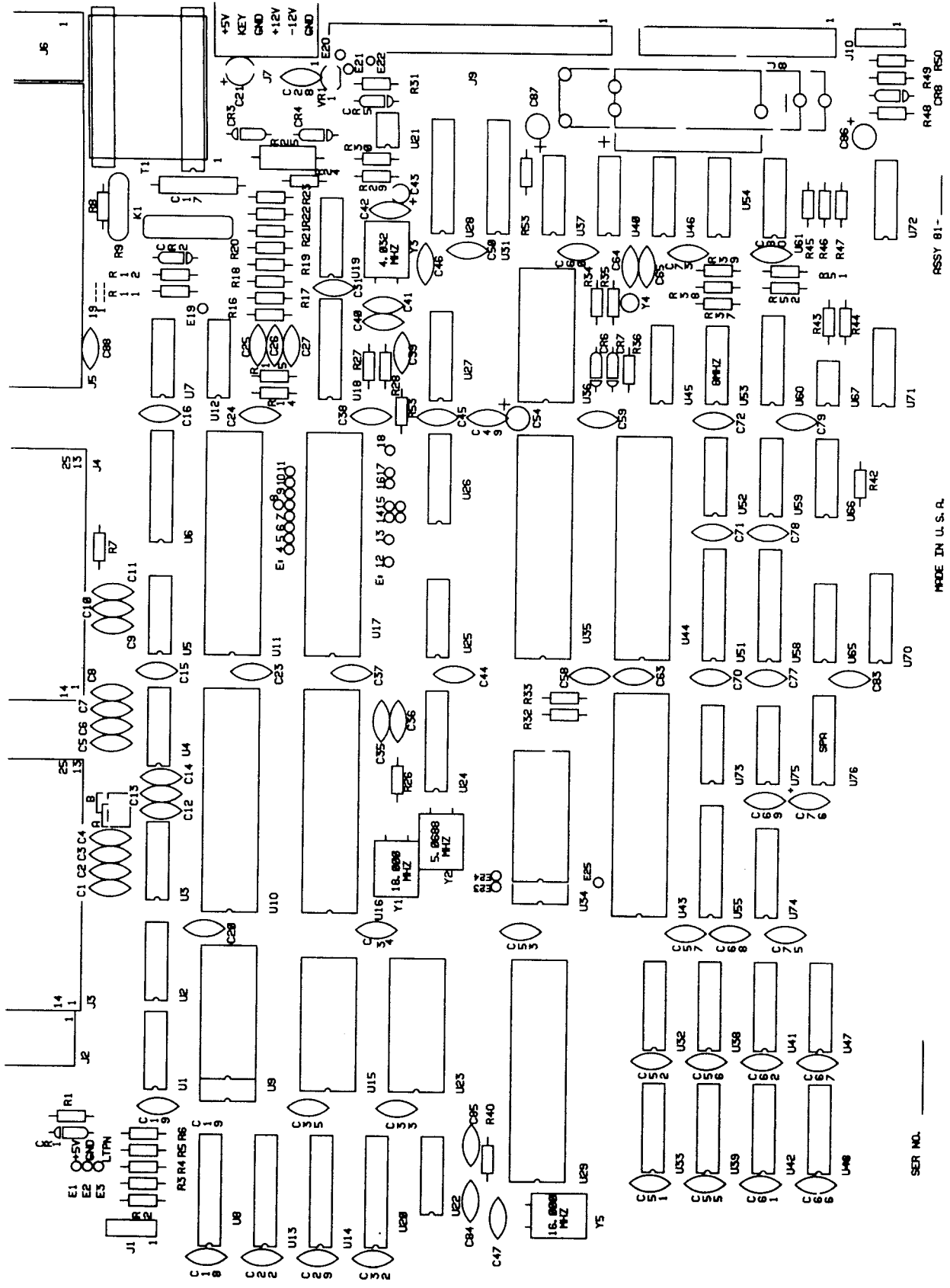

SER. NO. _____

MADE IN U.S.A.

RESSY 81- _____



IC LIST, 81-296-n

Reference Designation		Description
U1, U54	7406	Hex inverter, open collector
U2, U25, U71	74LS14	Hex Schmitt inverter
U3, U5	1489	Quad Schmitt line driver
U4	1488	Quad line driver
U6, U13, U14, U55, U58	74LS373	Octal "D" latch
U7	74LS38	Positive-NAND buffer
U8	74LS374	Octal "D" flip-flop
U9	81-235	Character PROM (2732)
U10	81-189	Custom gate array
U11, U17	Z80A SIO	
U12	LM324	Op-Amp
U15, U23	6116	Video RAM
U16	6545EA	Video controller
U18	TMS 99532	Modem
U19	TMS 99531	Dialer
U20, U31	74LS245	Octal bus transceiver
U21	4N35	Photo Isolator
U22	3.9K	Pullup resistor, 14-pin DIP
U24	WD1943/ 8116	Dual programmable baud rate generator
U26, U27	74LS138	3/8 MUX
U28, U51	74LS244	Octal buffer/line driver
U29	81-194	Custom gate array
U32, U33, U38, U39, U41, U42, U47, U48	2164	64K x 1 RAM
U34	81-326	Boot PROM (2764)
U35	Z80A PIO	
U36	MM581678	Clock
U37, U45, U59, U72	74LS02	Quad NOR gate
U40	74LS00	Quad NAND gate
U43	Z80A CPU	
U44	1793	Floppy disk controller
U46	74LS04	Hex inverter
U52	74LS32	Quad OR gate
U70, U74, U75		Spares
U60	74LS195	4-bit shift register
U61	74LS08	Quad AND gate
U65	74LS10	Tri NAND gate
U66, U75	74LS74	Dual "D" flip-flop
U67	FDC9216	Data separator
U73	74HC00	Quad NAND gate

SCOPE SIGNALS, 81-296-n

Scope signals for this mainboard will be available soon; the section will be sent to the dealers for insertion into the new Technical Reference Manual as soon as it is available.

REVISIONS		DATE	APPROVED
ZONE	UTR	EFFECT	DESCRIPTION

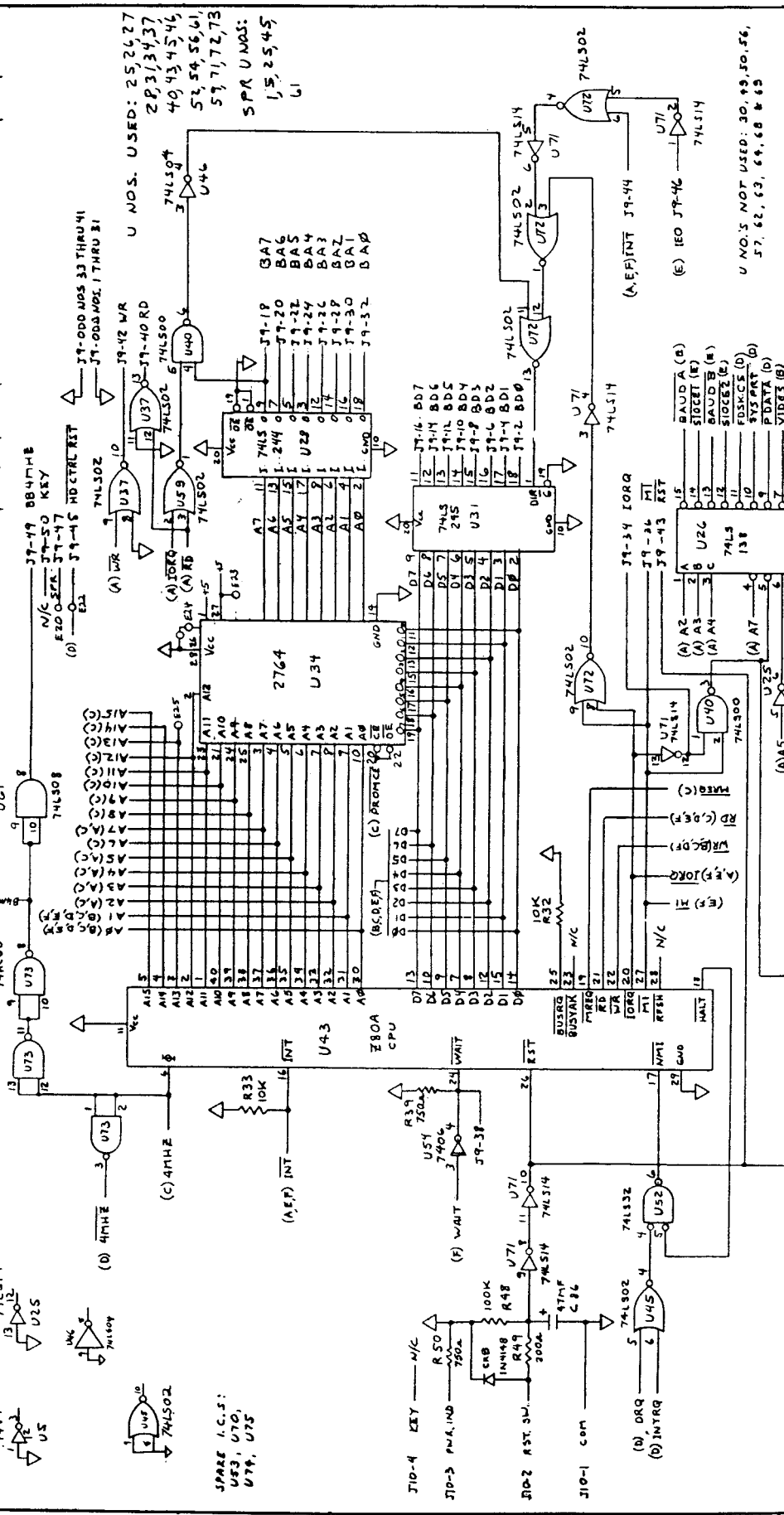

PARTS LIST		NOMENCLATURE OR DESCRIPTION		MFR. CODE		CIRCUIT ITEM NO.	
QTY	RECD	PART OR IDENTIFYING NO.	DESCRIPTION	CODE	REF.	NO.	NO.
15		74LS14	74LS14				
15		74LS02	74LS02				
15		74LS08	74LS08				
15		74LS16	74LS16				
15		74LS19	74LS19				
15		74LS20	74LS20				
15		74LS24	74LS24				
15		74LS27	74LS27				
15		74LS30	74LS30				
15		74LS32	74LS32				
15		74LS37	74LS37				
15		74LS38	74LS38				
15		74LS47	74LS47				
15		74LS48	74LS48				
15		74LS49	74LS49				
15		74LS50	74LS50				
15		74LS51	74LS51				
15		74LS52	74LS52				
15		74LS53	74LS53				
15		74LS54	74LS54				
15		74LS55	74LS55				
15		74LS56	74LS56				
15		74LS57	74LS57				
15		74LS58	74LS58				
15		74LS59	74LS59				
15		74LS60	74LS60				
15		74LS61	74LS61				
15		74LS62	74LS62				
15		74LS63	74LS63				
15		74LS64	74LS64				
15		74LS65	74LS65				
15		74LS66	74LS66				
15		74LS67	74LS67				
15		74LS68	74LS68				
15		74LS69	74LS69				
15		74LS70	74LS70				
15		74LS71	74LS71				
15		74LS72	74LS72				
15		74LS73	74LS73				
15		74LS74	74LS74				
15		74LS75	74LS75				
15		74LS76	74LS76				
15		74LS77	74LS77				
15		74LS78	74LS78				
15		74LS79	74LS79				
15		74LS80	74LS80				
15		74LS81	74LS81				
15		74LS82	74LS82				
15		74LS83	74LS83				
15		74LS84	74LS84				
15		74LS85	74LS85				
15		74LS86	74LS86				
15		74LS87	74LS87				
15		74LS88	74LS88				
15		74LS89	74LS89				
15		74LS90	74LS90				
15		74LS91	74LS91				
15		74LS92	74LS92				
15		74LS93	74LS93				
15		74LS94	74LS94				
15		74LS95	74LS95				
15		74LS96	74LS96				
15		74LS97	74LS97				
15		74LS98	74LS98				
15		74LS99	74LS99				

NON-LINEAR SYSTEMS, INC.
DEL MAR, CALIFORNIA

SCHEMATIC PROCESSOR

ROBIE

SIZE CODE IDENT NO. C 03626

81-297

SCALE WEIGHT SHEET 2A

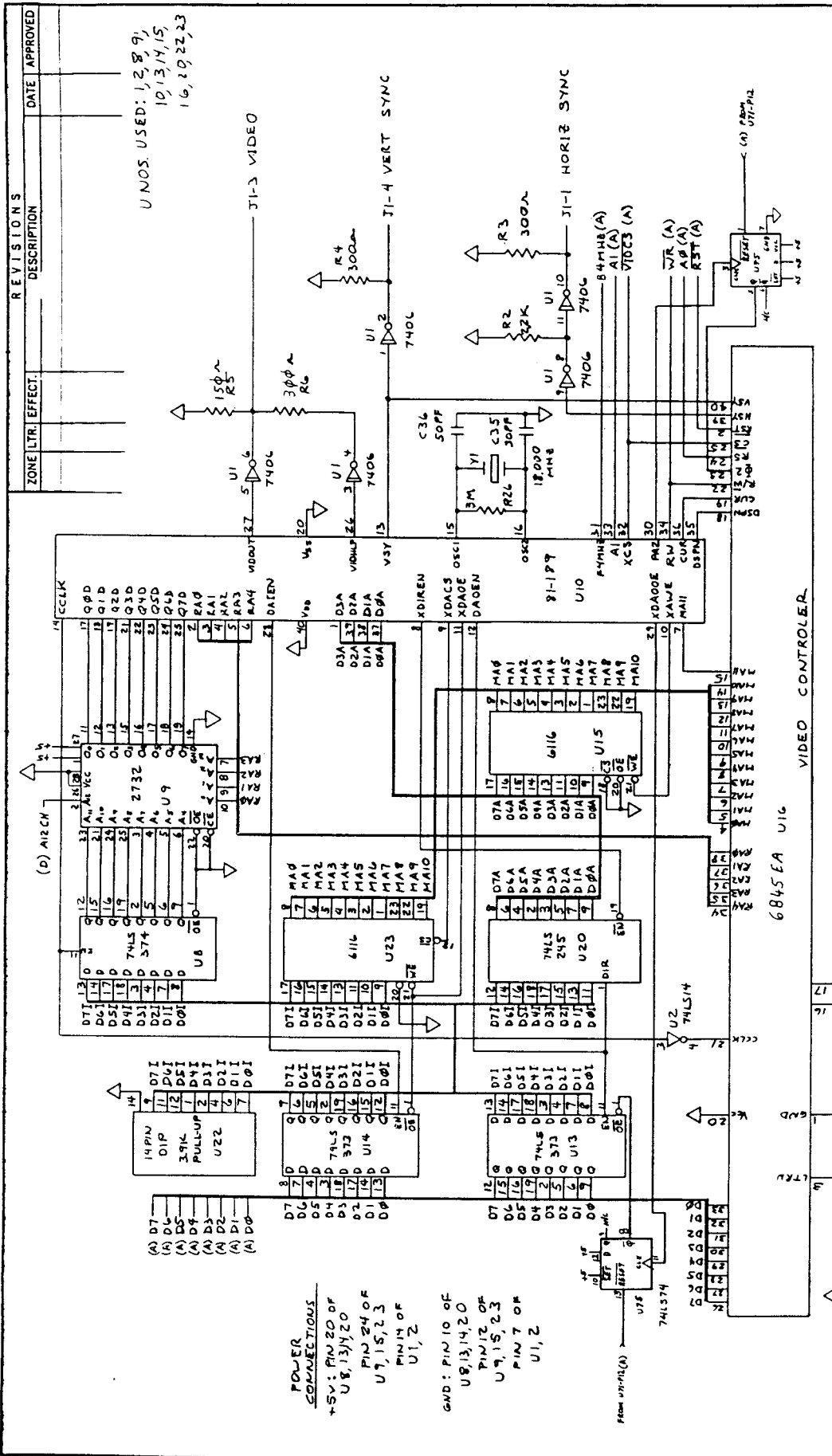

ZONE	LTR.	EFFECT.	DESCRIPTION	DATE	APPROVED

U NOS. USED: 1, 2, 8, 9,
10, 13, 14, 15,
16, 20, 22, 23

TI-3 VIDEO
TI-4 VERT SYNC
TI-1 HORIZ SYNC

POWER CONNECTIONS
+5V: PIN 20 OF U8, 13, 15, 20
PIN 24 OF U7, 15, 2, 3
PIN 14 OF U1, 2
GND: PIN 10 OF U8, 13, 14, 20
PIN 12 OF U7, 15, 2, 3
PIN 7 OF U1, 2

QTY	RECD	PART OR IDENTIFYING NO.	NOMENCLATURE OR DESCRIPTION	MFR. CODE	CIRCUIT REF.	ITEM NO.

UNLESS OTHERWISE SPECIFIED		CONTR. NO.
DIMENSIONS ARE IN INCHES		
TOLERANCES ON DECIMALS		
ANGLES		
FRACTIONS		
MATERIAL		

APPLY	QTY.

PROPRIETARY INFORMATION
Not for distribution or transmission to any other person or organization or company without the permission of Kyjuro Corporation

SIZE	CODE IDENT NO.	WEIGHT	SHEET
C	03626		28

REVISIONS		DATE	APPROVED
ZONE	LTR. EFFECT.	DESCRIPTION	

U NOS. USED: 23, 45, 11, 17, 24, 25

J4: SERIAL DATA CHANNEL

J4 PINS N/C: 9-14, 16, 19, 21-25

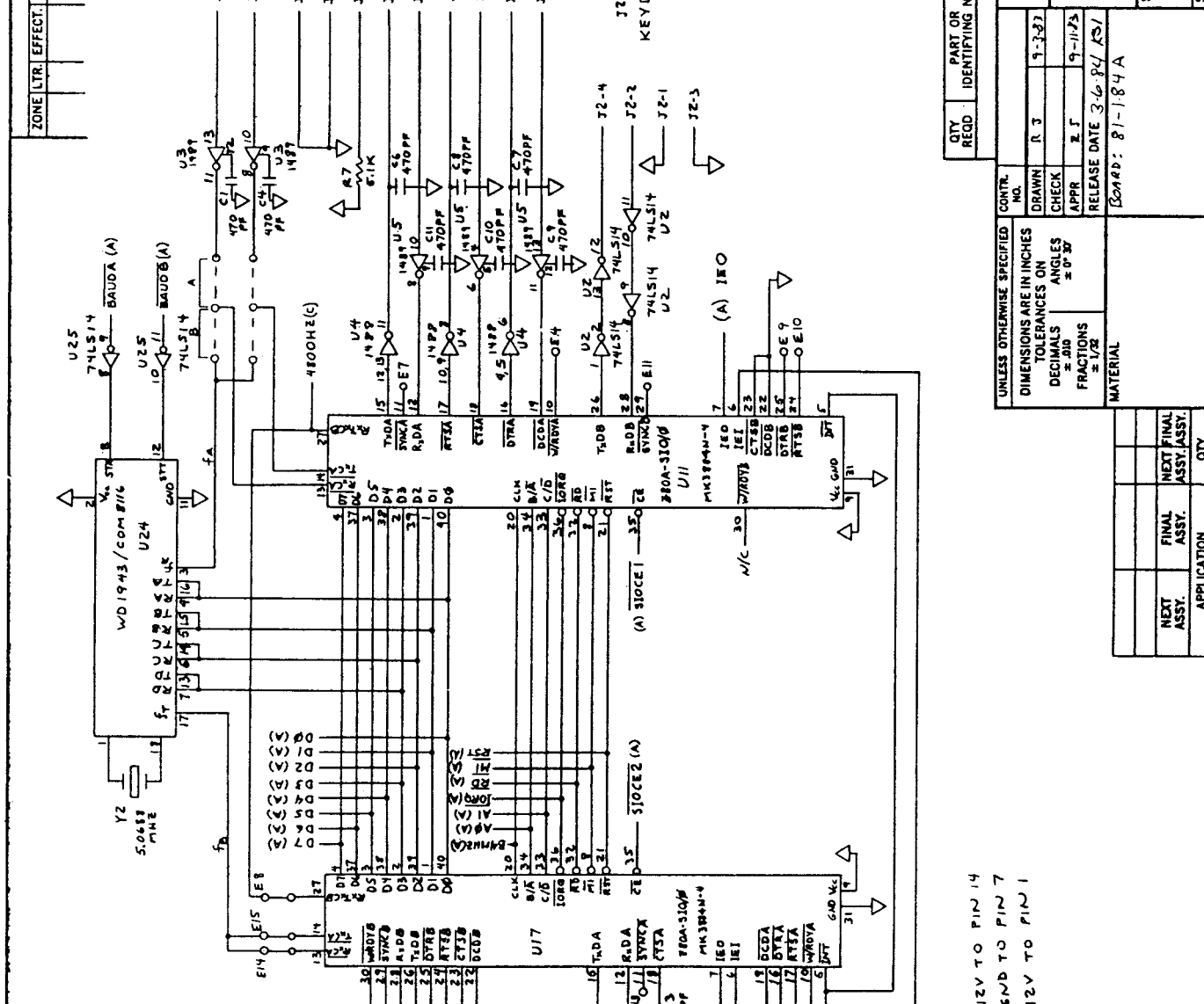

J3: SERIAL PRINTER
4-6, 8-19, 21-25

J2: KEYBOARD

UNLESS OTHERWISE SPECIFIED
DIMENSIONS ARE IN INCHES
TOLERANCES ON DECIMALS ON ANGLES ±0.037

RELEASE DATE 3-6-84 KSI
BOARD: 81-184A

QTY REQD: PART OR IDENTIFYING NO. Nomenclature or Description PARTS LIST

MFR CODE CIRCUIT ITEM REF. NO.

NON-LINEAR SYSTEMS, INC.
DEL MAR, CALIFORNIA

SHEMATIC, SERIAL PORTS

SIZE CODE IDENT NO. C 03626

SCALE WEIGHT SHEET 2 E

PROPRIETARY INFORMATION

Not for distribution or transmission to any other person or organization or company without the permission of Kaypro Corporation

PWR TO U4: +12V TO PIN 14
GND TO PIN 7
-12V TO PIN 1

6.7 MAINBOARD REMOVAL

1. Turn off the machine and disconnect the AC power (5.1).
2. Remove the chassis hood (5.1).
3. Remove the two screws from the front of the mainboard that attach the mainboard and the two plastic standoffs.
4. Remove the screws from the rear, top of the chassis that secure the mainboard. The KAYPRO 2/83 and 4/83 each have four Phillips-head screws and two hex-head screws. The KAYPRO 10, 2/84 and 4/84 each have three Phillips-head screws and four hex-head screws.
5. Remove the power, reset, and video plugs. On the KAYPRO 2/83 and 4/83 these are J1, J5, and J7. On the KAYPRO 10, 2/84 and 4/84 these are J1, J7, and J10.
6. Remove the ribbon cable(s). On the KAYPRO 2/83 and 4/83 this is J6. On the KAYPRO 10 they are J8 and J9. On the KAYPRO 2/84 and 4/84 this is J8.
7. Remove the mainboard.

MAINBOARD INSTALLATION

1. Set the mainboard on the plastic standoffs, insert the screws, but do not tighten them yet.
2. Align the ports and the keyboard jack with the openings on the rear, top of the chassis.
3. Insert the screws through rear of chassis into mounting holes. Do not tighten yet.
4. The KAYPRO 2/83 and 4/83 each have four Phillips-head and two hex-head screws. The KAYPRO 10, 2/84 and 4/84 each have three Phillips-head and four hex-head screws.
5. Tighten the screws on the rear of the chassis and the screws that go into the plastic standoffs.
6. Replace the power, reset, and video plugs.
7. Replace the ribbon cable(s).

7.0 CRT ASSEMBLIES

7.1 HARDWARE DESCRIPTIONS AND ADJUSTMENTS

Figure 7.1
Dotronix video board

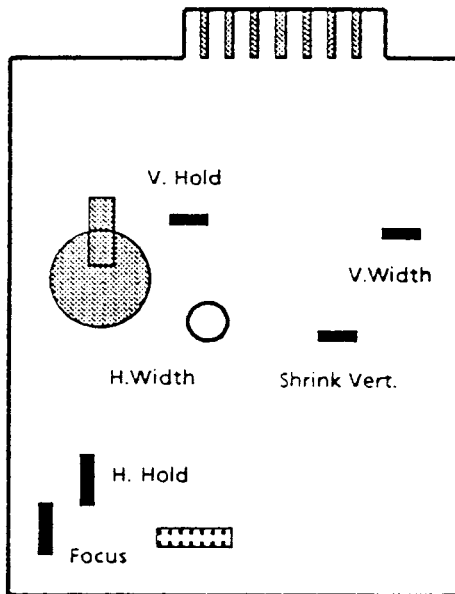
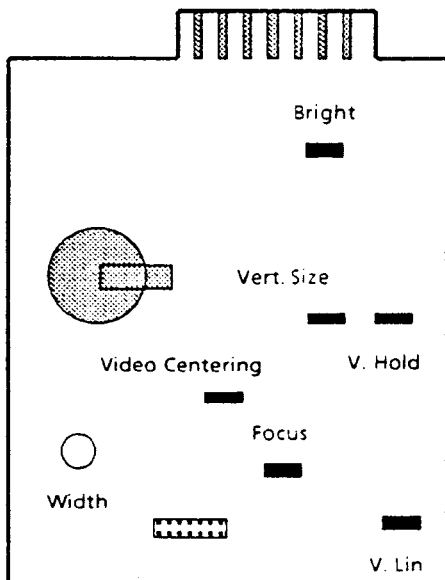

Figure 7.2
Elston video board



VIDEO ADJUSTMENTS

At the current time Kaypro is using CRT assemblies produced by Dotronix, Elston, and Toshiba. The adjustment pots are positioned in different locations on the boards and can be located by using figures 7-1, 7-2, and 7-3. These pots are factory aligned and normally need no adjustment. The purpose of these adjustments is to obtain the correct size, centering, and brightness of the display.

Use only non-metallic tools when making these adjustments.

Before any adjustments are made on the video board, the ALIGN diagnostic should be invoked. This will fill the screen with H's and aid in adjustment.

HORIZONTAL CENTERING

Check to see that the pattern is centered on the screen. Adjust the horizontal hold pot until the display is correctly centered. On the Elston video board, adjust the video centering pot.

VERTICAL SIZE AND LINEARITY

The following two procedures are to be performed alternately until correct display is obtained.

Adjust the vertical size pot to obtain pattern height of approximately 4-7/8 inches.

Adjust vertical linearity pot until all characters are the same vertical size, top to bottom.

HORIZONTAL WIDTH

Adjust the horizontal width pot to obtain a display width of approximately 7 inches.

HORIZONTAL HOLD (KAYPRO 2/83 and 4/83 with Dotronix only)

Figure 7.3
Toshiba video board

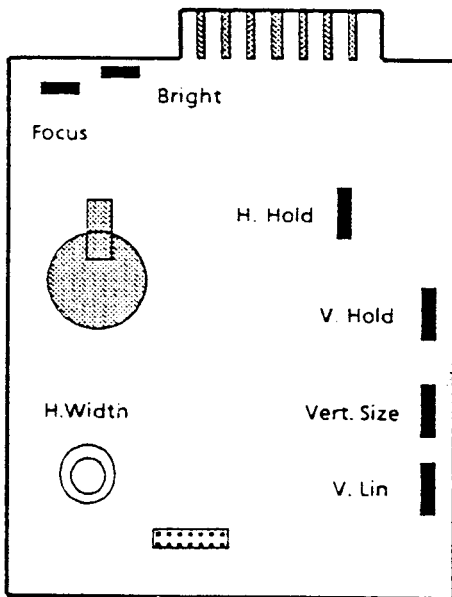

These procedures should be performed to adjust horizontal hold.

Attach one end of a test jumper to TP2 (test point 2). Attach the other end of the jumper to the heat sink at Q3.

Adjust R43 (horizontal hold pot) until the display either stops scrolling or almost stops. (sometimes they don't stop scrolling completely)

Disconnect the test jumper.

Adjust the horizontal deflection rings as needed.

FOCUS

Adjust the focus pot until the edges and center of the display image are in focus.

BRIGHTNESS

To prolong the life of the CRT, the maximum brightness obtainable should not be excessive. If the brightness is excessive, adjust the brightness pot. If the raster lines are visible, the brightness pot should be adjusted until they disappear.

Figure 7.4
Yoke alignment

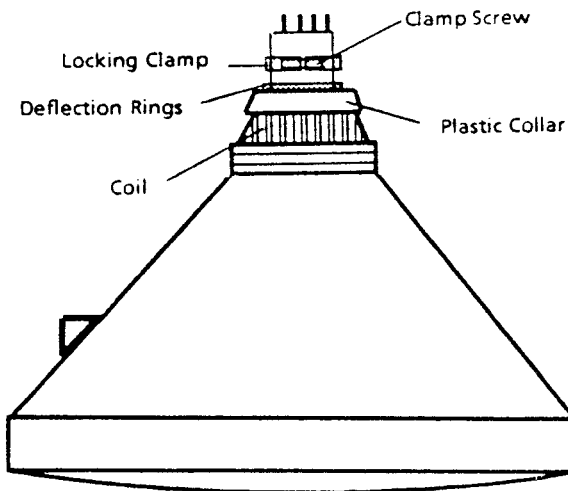

ALIGNING CRT YOKE

*** CAUTION ***

HIGH VOLTAGE IS PRESENT AT THIS POINT

Loosen the screw on the locking clamp (figure 7-4).

Grasp the white collar on the rear of the coil.

Turn the collar in the direction required to square the display.

Turn the collar slightly past the alignment point, as it will turn back slightly when released.

Tighten the locking screw.

VIDEO ADJUSTMENTS FOR MICREX CRT

The same procedures should be used to adjust the Micrex CRT assembly as those used for the other brands of CRTs.

Figure 7.5
Micrex video board

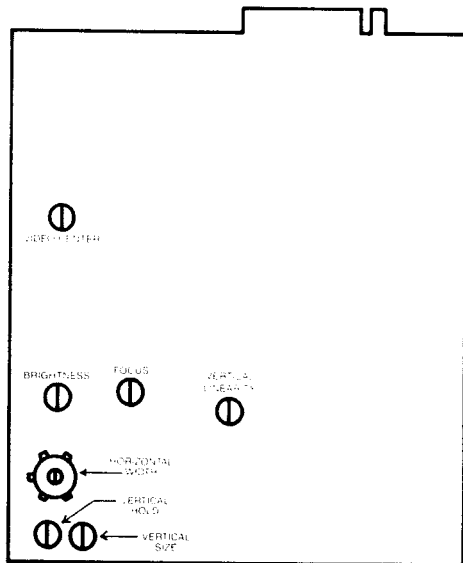

7.2 PERFECT VIDEO ALIGNMENT EXAMPLE

Below is an example of perfect video alignment with a capital E positioned along the borders. You can copy this diagram onto a piece of clear, stiff plastic to use as a template over the screen.

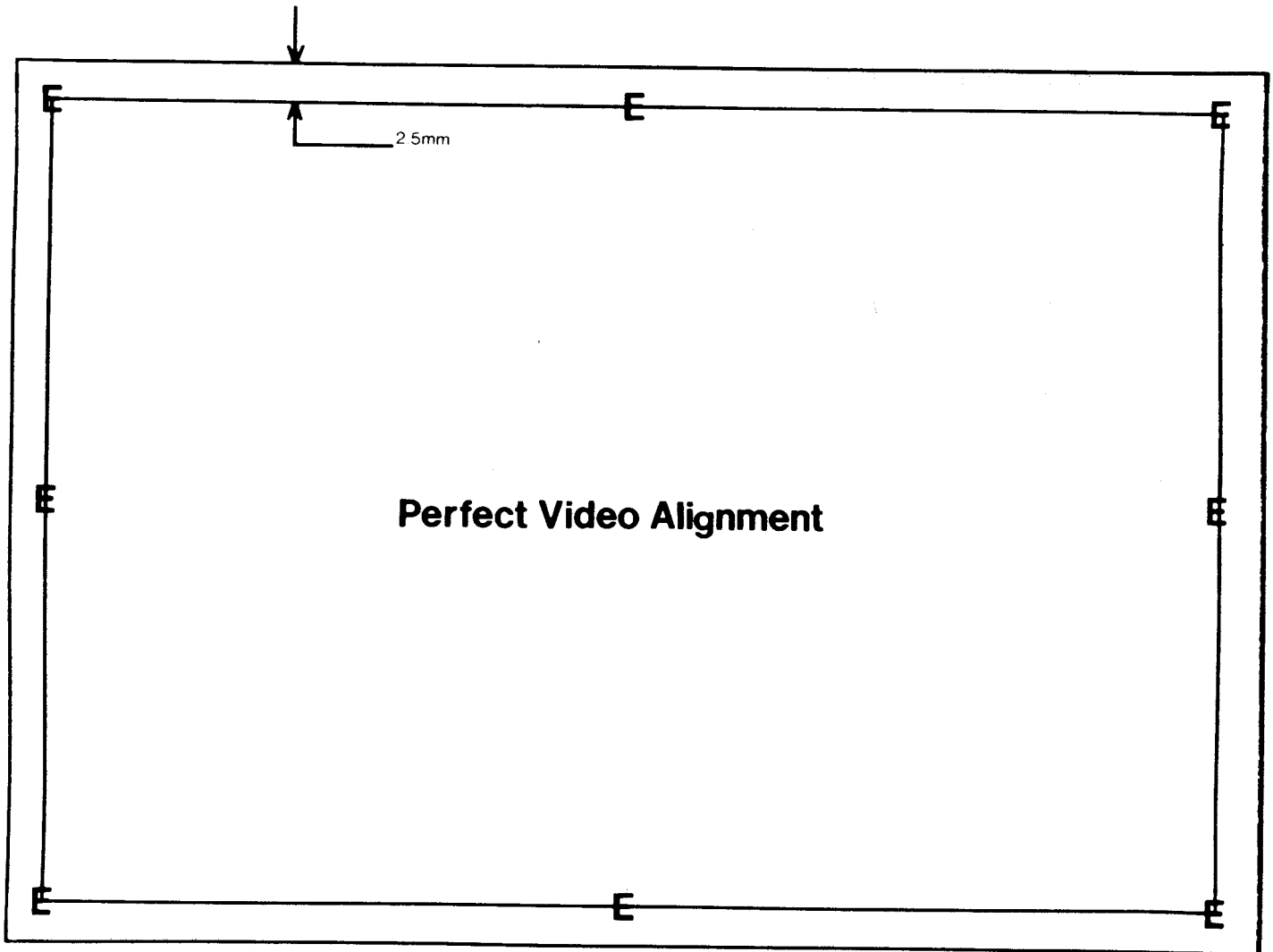

7.3 VIDEO SIGNALS, ON KAYPRO MAINBOARD

Below is a list of the video signals on connector J1 of the mainboard and the voltages on the video board. Repeated removal and installation of the video board connector will loosen the connection and produce poor contact. Malfunctions due to a loose connector can be very difficult to trace.

Video comes from the main board as separate signals, not as a composite like a TV signal.

A simple check for 12V on the video board is to turn the BRIGHTNESS pot up, then turn the rear panel brightness control down. If 12V is present on the board, you should be able to see the raster lines on the screen.

Video signals on main board at J1

Pin 1 - Horizontal Sync.
Pin 2 - Key
Pin 3 - Video
Pin 4 - Vertical Sync.

Voltages on Video Board

Pin 1 → 0v
Pin 6 → 0v
Pin 7 → 12v
Pin 8 → 0v
Pin 9 → 4v approx. (this voltage controls brightness)
Pin 10 → 0v

7.4 LISTING OF ALIGN.MAC

If you have the assembly language utilities M-80 and L-80, this diagnostic can be typed into the KAYPRO, then turned into a COM file by running M-80, then L-80.

```
*****
; kaypro alignment test routine
;
; first a program to move this routine above 8000h
; so we can turn on the other page of memory
; and address the video page directly
;
start:
    ld    hl,first+1
    ld    de,dest
    ld    bc,last-first1
    ldir
    jp    dest
;
dest    equ    08000h
first:  defb   0
;
        .phase dest
;
;beginning of the program
; first turn off the drives and turn on the vid page
;
first1:
    in    a,(01ch)
    set   7,a    ;turn on the vid page
    set   6,a    ;turn off drives
    res   0,a    ;turn off drive a light
    res   1,a    ;turn off drive b light
    out  (01ch),a
;
    ld    hl,3000h    ;beginning of the vid page
    ld    (hl),'H'
    ld    de,3000h+1
    ld    bc,3*1024    ;how many
    ldir
;
; now vid page filled with H
;
    ld    hl,msg1
    ld    de,03580h    ;line 12
    ld    bc,80
    ldir
;
    ld    hl,msg2
    ld    de,03600h    ;line 13
    ld    bc,80
    ldir
```

7.4 ALIGN.MAC LISTING (CONTINUED)

```

;
loop:      call    delay
           call    aon
           call    delay
           call    aoff
           call    delay
           call    bon
           call    delay
           call    boff
           jp     loop

;
;
aon:      in     a,(01ch)
           set   0,a
           out  (01ch),a
           ret

aoff:     in     a,(01ch)
           res  0,a
           out  (01ch),a
           ret

bon:      in     a,(01ch)
           set  1,a
           out  (01ch),a
           ret

boff:     in     a,(01ch)
           res  1,a
           out  (01ch),a
           ret

;
delay:    ld     bc,2
delay0:   ld     hl,0
delay1:   dec    hl
           ld   a,h
           or   l
           jp   nz,delay1
           dec  bc
           ld   a,b
           or   c
           jp   nz,delay0
           ret

;

```

7.5 CRT ASSEMBLY REMOVAL, (EXCEPT ROBIE)

1. Turn off the machine and disconnect the AC power (5.1).
2. Remove the chassis hood (5.1).
3. Remove the mainboard (6.7).
4. Remove the four screws that connect the video PCB and the bottom of the chassis. This should be done from the outside, bottom of the chassis, not from inside the machine.
5. Remove the video connector from the back of the video PCB.
6. Remove the four screws that connect the CRT to the front of the machine chassis.
7. Remove the CRT assembly from the chassis.
8. Remove the four plastic standoffs from the CRT PCB. These can be used on the new CRT PCB.

CRT ASSEMBLY INSTALLATION

*** Note: Before starting with CRT installation, check to see if the small plastic standoffs are attached to the bottom of the CRT PCB. If they are not attached, use the ones from the old board.

1. Lower the CRT assembly into the chassis.
2. Position the CRT so that the top mounting holes are aligned with the two metal standoffs on the chassis.
3. Insert screws through the top two mounting holes on the CRT and into the standoffs, but do not tighten.
4. Insert screws through the bottom two mounting holes on the CRT and into the standoffs. Tighten these two screws and the top two screws.
5. Hold the CRT PCB in place and tilt the machine up so that it is sitting on the cord wraps.
6. Align the plastic standoffs on the PCB with the holes in the bottom of the chassis.
7. Insert the four screws and tighten securely.
8. Replace the video connector on the back of the video PCB.

8.0 POWER SUPPLIES

8.1 INTRODUCTION

Kaypro is using three different brands of power supplies at the present time. These are Astec, Boschert, and Cal D.C. These three power supplies are interchangeable with any of the Kaypro computers, if the power supply being changed is a new one from the factory.

*** EXCEPTION ***

If a power supply is removed from a 2/83 or a 4/83, and it's going to be used in another computer, it MUST be used in a 2/83 or 4/83. The power supplies used in 2/83 and 4/83 computers are not interchangeable with other Kaypro computers.

There are no authorized dealer repairs that can be made on any of the power supplies. The ONLY authorized dealer service to power supplies is 220V configuration. Each brand of power supply can be configured for 220V operation.

8.2 DESCRIPTION AND 220V CONFIGURATION INSTRUCTIONS

Two fuses are associated with each of the power supplies. One fuse (2 amp) is mounted on the rear of the chassis and accessible from outside the computer. The other fuse (2.5 amp) is mounted directly on the power supply board.

Disconnect AC power from the computer whenever replacing fuses. Be especially careful when replacing the fuse on the power supply board. Use of a fuse replacement tool is recommended due to the difficulty of reaching this component.

220V CONFIGURATION

Astec Power Supply

Identified by a beige board with a white label on the right of the component side. The label will have the name ASTEC, followed by a model number, and the output voltages.

Locate the white shorting block labelled TB2. If the board is configured for 110V, a pin will be visible on the right of the shorting block.

Remove the shorting block and shift it to the right so that it covers the pin. A different pin should now be exposed on the left of the shorting block. The power supply is now configured for 220V use.

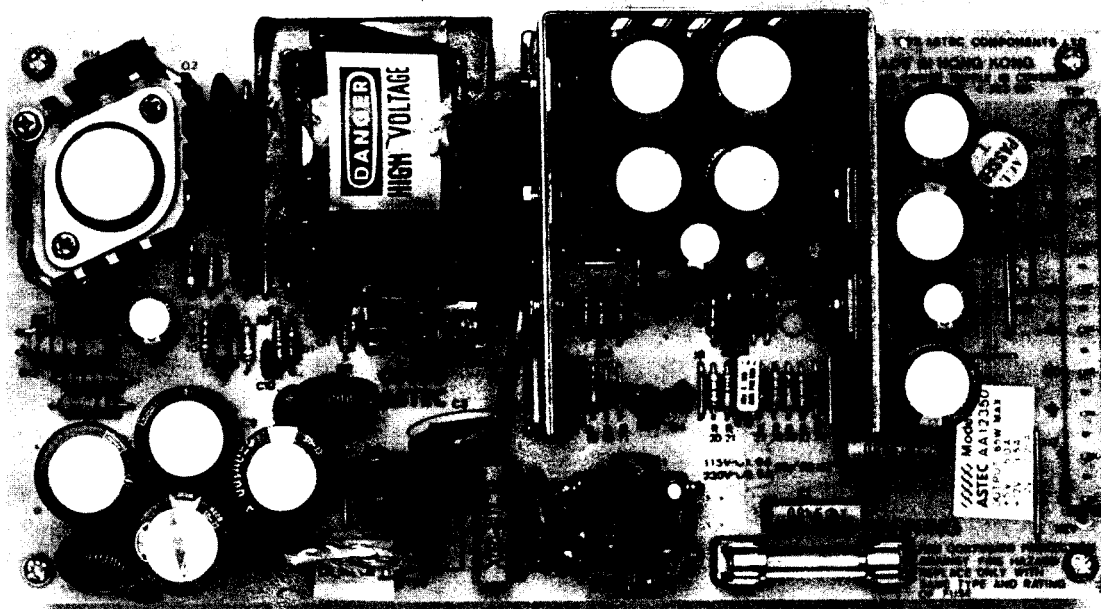

220V CONFIGURATION

Boschert Power Supply

Identified by the word "Boschert" on the component side of the board at lower right and above the fuse and capacitor C2.

Locate a six-inch wire that is soldered to point JP1. If the board is configured for 110V, the other end of the wire is attached to point E1 (labelled 110V).

Unplug the wire from point E1 and plug it into point E2 (labelled 220V). Point E2 is to the left of point E1. The power supply is now configured for 220V use.

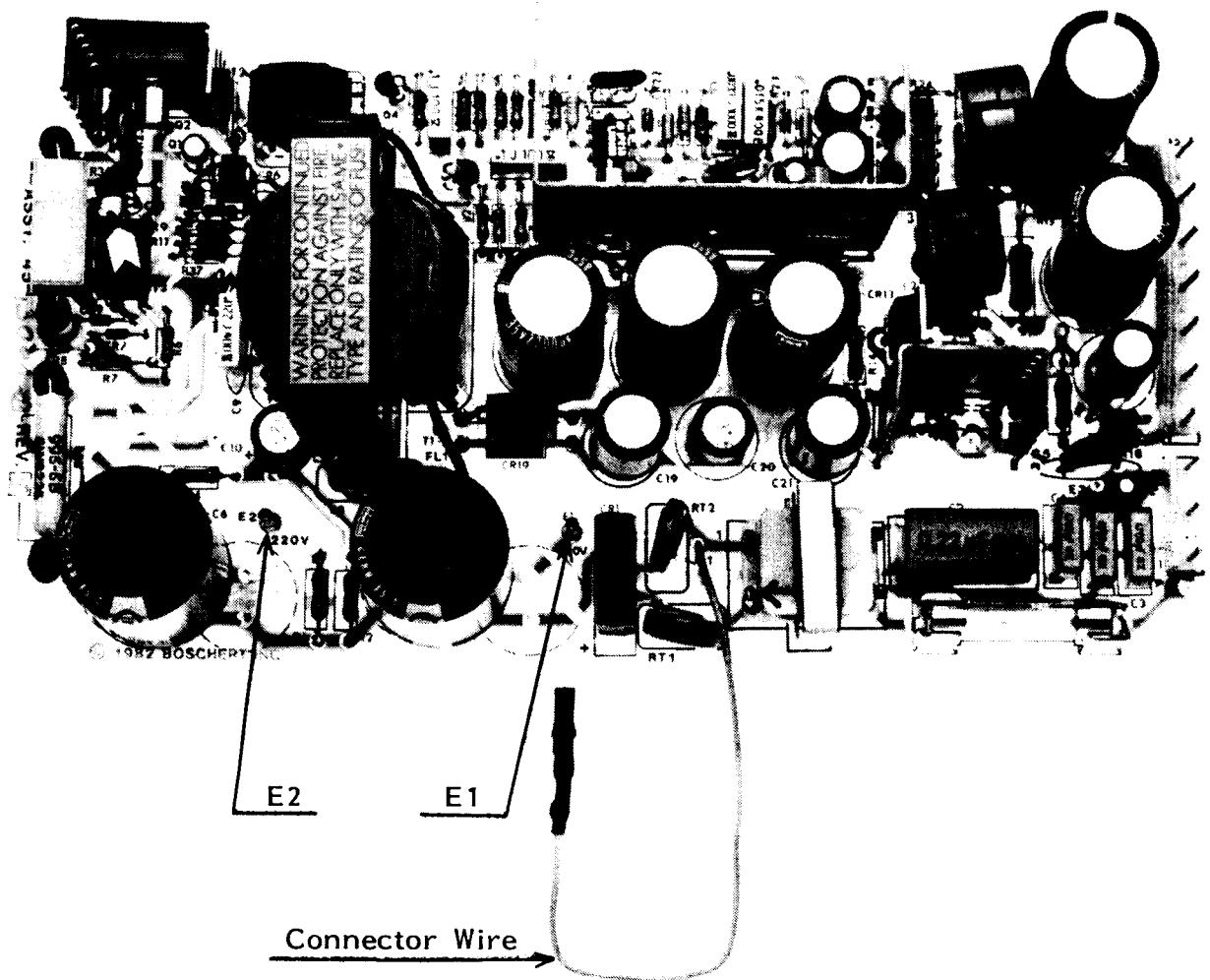

220V CONFIGURATION

Cal D.C. Power Supply

Identified by a bright blue circuit board. A white sticker with "California DC", model, and serial number is located on solder side of board.

There are two ceramic power resistors in the upper right-hand corner of the board. These resistors get quite hot during operation. Wiring should be tied down AWAY FROM THESE COMPONENTS.

Locate a jumper block labelled 115VAC and 230VAC. With the jumper in the 115VAC position the board is configured for 110V.

Remove the jumper from the socket labelled 115VAC and replace it in the socket labelled 230VAC. The power supply is now configured for 220V use.

CALIFORNIA DC POWER SUPPLY

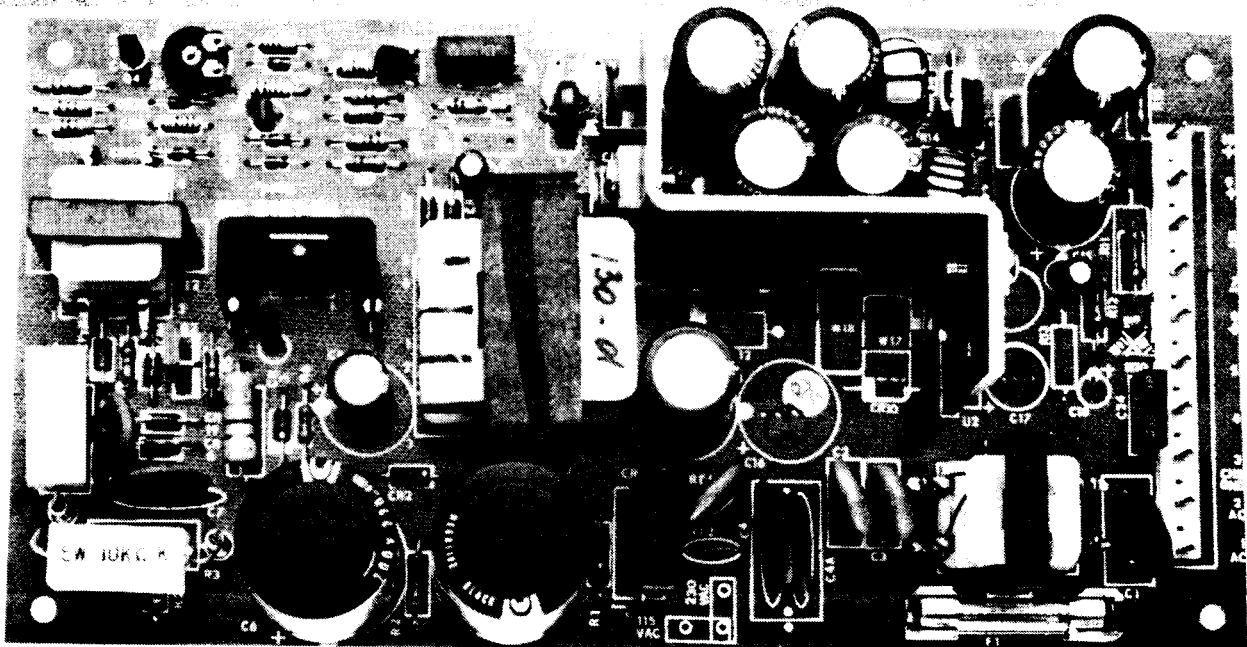

Jumper Sockets

8.3 POWER SUPPLY REMOVAL

1. Turn off the machine and disconnect the AC power (5.1).
2. Remove the chassis hood (5.1).
3. Remove the mainboard (6.7).
4. Remove the four screws that connect the power supply and the back of the chassis. These are easier to remove from outside the back of the chassis than from inside the machine.
5. Remove the power plug from the power supply.
6. Remove the tie wraps from the plastic standoffs.
7. Remove the power supply.

POWER SUPPLY INSTALLATION

1. Position the power supply inside the chassis so that the four plastic standoffs are aligned with the four mounting holes in the chassis. Be certain that the power connector is on the side nearest the drives.
2. Place the tie wraps on the plastic standoffs.
3. Insert four screws through the rear of the chassis and into the plastic standoffs of the power supply.
4. Tighten the screws securely.
5. Replace the power connector.
6. Replace the mainboard (6.7).
7. Replace the chassis hood (5.1).

9.0 DISKETTE DRIVES

9.1 INTRODUCTION

All diskette drive types (except the high-density drives in the ROBIE and 4X) are functionally interchangeable between manufacturers.

Because of the number of manufacturers from which Kaypro gets its diskette drives, no attempt is made in this manual to show alignment procedures for each of the drives. If you have access to a drive manual for a particular model, and have the Dysan Alignment Diskette (Dysan's part number: 224/2A) the knowledge, and an oscilloscope, go ahead and align away. Kaypro Corporation's policy is to do no repairs on these components.

However, since the company recognizes the fact that many customers want a KAYPRO computer in which both drives have the same outward appearance, we provide a guide for determining models of diskette drives from the placement of the LED and the drive door closure.

This section also contains diagrams and instructions on jumpering the various models of diskette drives to be used as either A or B (or, in the case of the KAYPRO 10, C) drive.

DISK DRIVE CLEANING

Generally speaking the majority of people clean disk drives too often. Unless the environment is especially dusty or dirty, under commercial use there is no reason to clean the drives more than twice a year.

Use care in selecting a cleaning kit. Many of the drive head cleaning kits on the market are very abrasive. Cleaning is done by the liquid solution, not by mechanical scrubbing.

*****NOTE***** The manufacturer (Drivetec) of the high-density drives in the ROBIE, and 4X recommends only four brands of head-cleaning kits for their drives. The letter from Drivetec states:

"THE FOLLOWING CLEANING DISKS HAVE BEEN EVALUATED
AND ARE RECOMMENDED FOR USAGE ON THE DRIVETEC DISK
DRIVE WHEN HEAD CLEANING IS DEEMED NECESSARY:

- 1) SCOTCH #7440
- 2) HEAD COMPUTER PRODUCTS 5 1/4 CLEANING DISK
- 3) PERFECT DATA 5 1/4 CLEANING DISK
- 4) FLOPPICLENE 5 1/4 CLEANING DISK"

Refer to the symptom-fix guide for troubleshooting hints relative to the floppy drives, the Winchester hard disk, and the Drivetec (high-density) drives.

9.2 WHICH BRAND OF DRIVE IS IT?

The following figures represent the face plates of the different brands of half-height floppy drives that are used in Kaypro computers. The drive door closure and the LED position can be used to reference the drive.

Fig. 9.1, TANDON Half-Height

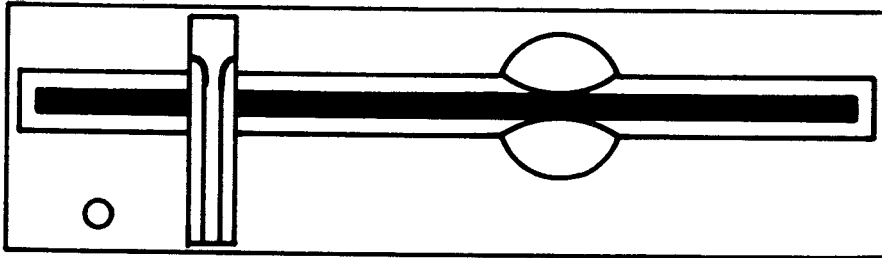

Fig. 9.2, EPSON

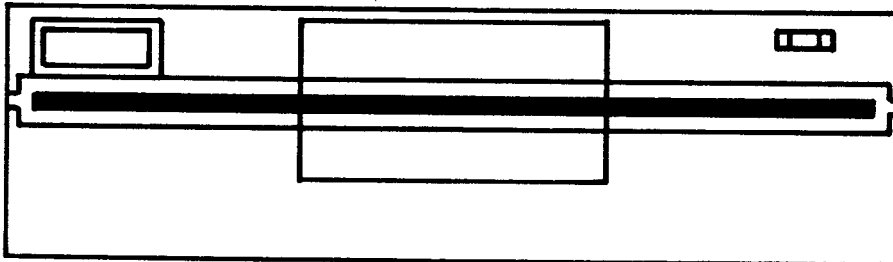

Fig. 9.3, SHUGART

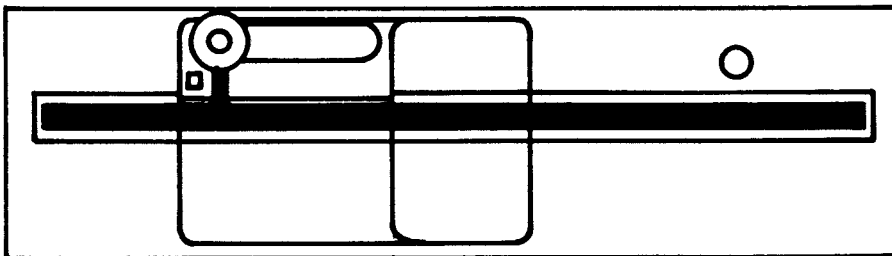

Fig. 9.4, TOKYO ELECTRIC

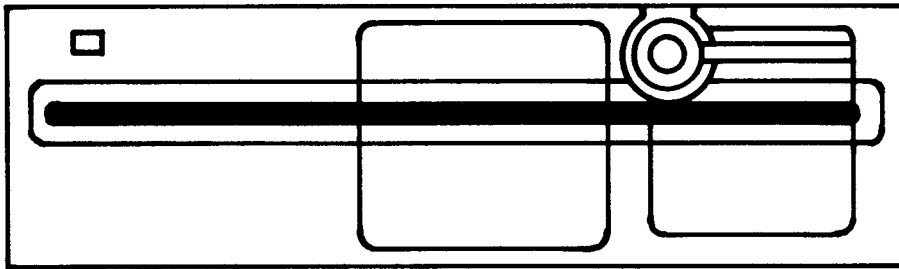

Fig. 9.5, TOSHIBA

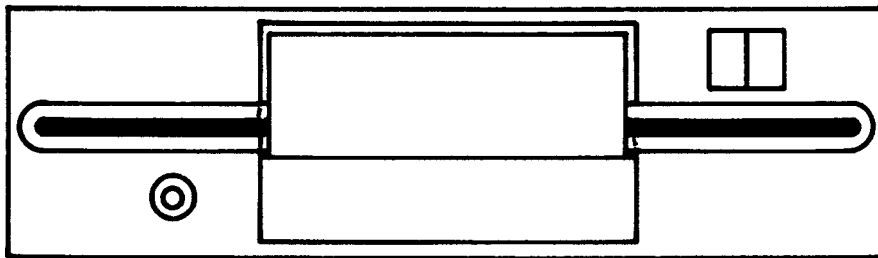

Fig. 9.6, HI-TECH

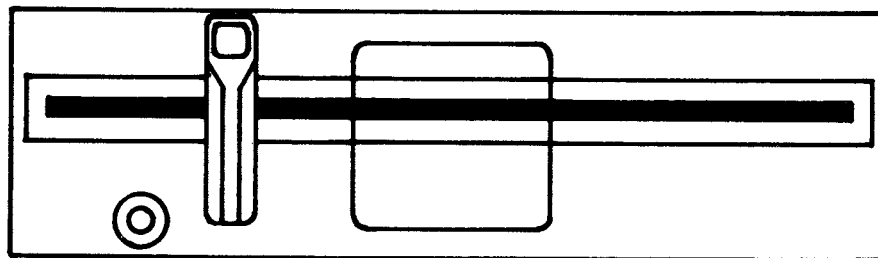

Fig. 9.7, DRIVETEC

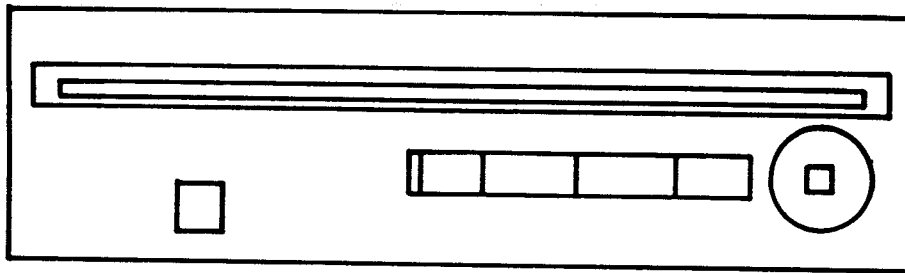
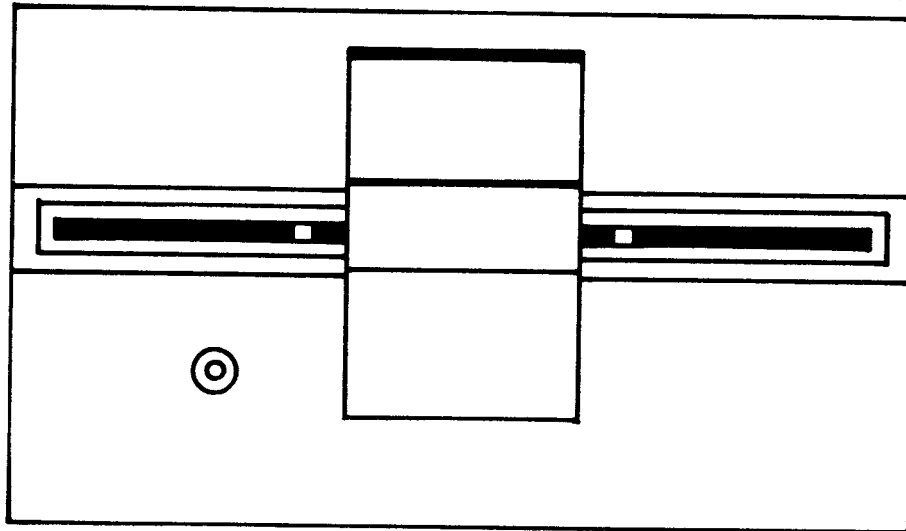
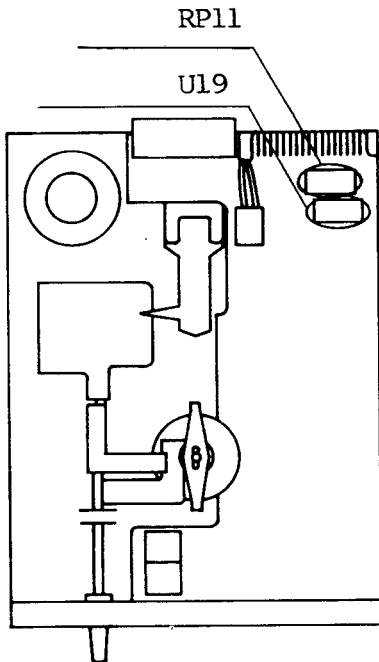

Fig. 9.8, TANDON Full-Height



9.3 JUMPERING DIAGRAMS

Figure 9.8
Tandon diskette drive



TANDON

Used only on KAYPRO 10, Pins 2 and 15 on U19 are jumpered and a 470-ohm terminating resistor pack is inserted in RP11.

Figure 9.9
Epson diskette drive

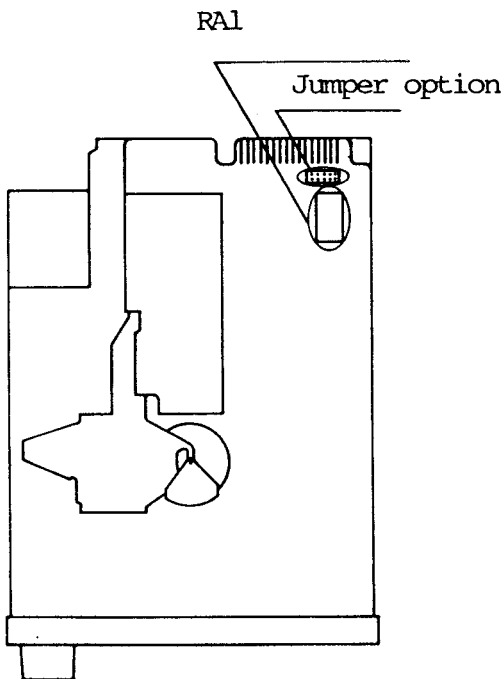

EPSON

Next to the connector for the data cable is a black plug with ten pins. These pins are jumpered to change the configuration of the drive. They are MX, 0, 1, 2, 3.

KAYPRO 10: The two pins in the "0" position should be jumpered and a 470-ohm terminating resistor inserted in RAL.

A DRIVE: Jumper the two pins in the "0" position. No terminating resistor is needed.

B DRIVE: Jumper the two pins in the "1" position. Insert a 470-ohm terminating resistor into RAL.

Figure 9.10
Shugart diskette drive

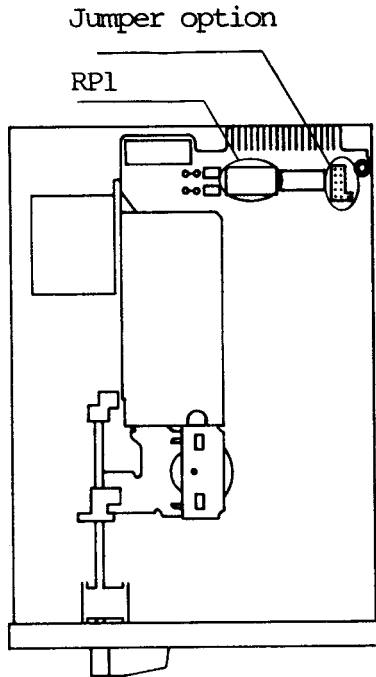

SHUGART

Next to the connector for the data cable is a blue plug with eleven pins. These pins are 1, 2, 3, 4, MX.

KAYPRO 10: Jumper the two pins in the "1" position. In the "MX" position, there are three pins. Jumper the one in the center and the one on the left of it. Insert a 470-ohm terminating resistor into RPl.

A DRIVE: Jumper the two pins in the "1" position. In the "MX" position, jumper the pin in the center and the pin on the left of it. No terminating resistor is necessary.

B DRIVE: Jumper the two pins in the "2" position. In the "MX" position, jumper the pin in the center and the pin on the left of it. Insert a 470-ohm terminating resistor into RPl.

Figure 9.11
Tokyo Electric
diskette drive

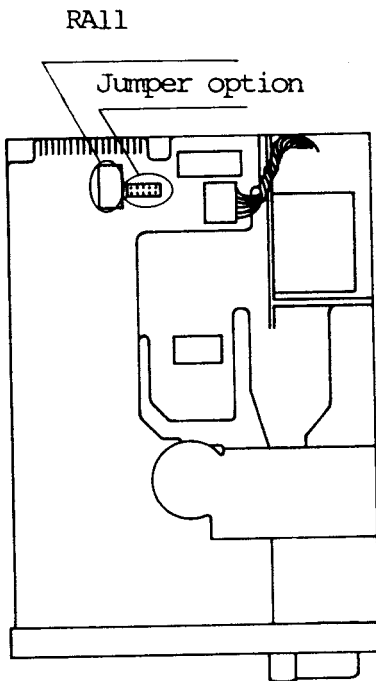

TOKYO ELECTRIC

Next to the connector for the data cable is a blue plug with ten pins. These pins are DS0, DS1, DS2, DS3, MX.

KAYPRO 10: Jumper the two pins in the "DS0" position. Insert a 470-ohm terminating resistor into RAll.

A DRIVE: Jumper the two pins in the "DS0" position. No terminating resistor is necessary.

B DRIVE: Jumper the two pins in the "DS1" position. Insert a 470-ohm terminating resistor into RAll.

Figure 9.12
Toshiba diskette drive

Jumper option

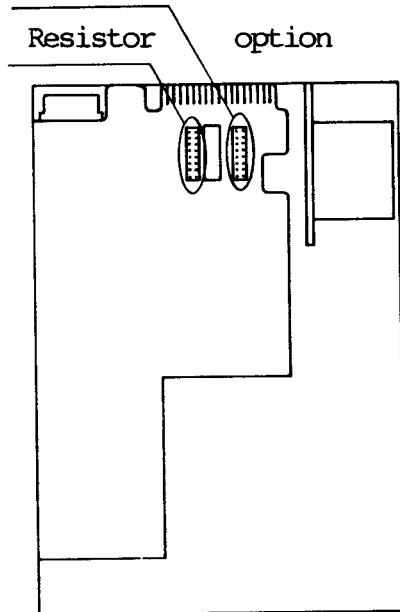

TOSHIBA

Next to the connector for the data cable is a black plug with sixteen pins. These are 1, 2, 3, 4, LI, LD, HD, HM. Next to the black plug, is a 470-ohm terminating resistor with the letters "DM" to the left of it. Locate this resistor. On the other side of the resistor is another black plug. This plug has the letters "RM" to the left of it and the letters "PJ5" to the right of it. It has sixteen pins. For the terminating resistor to function, all pins must be jumpered EXCEPT the two next to the letters "RM". When the resistor is not needed, none of the pins should be jumpered.

KAYPRO 10: Jumper the two pins in the "1" position, the two pins in the "LD" position, and the two pins in the "HM" position. The terminating resistor is needed.

A DRIVE: Jumper the two pins in the "1" position, the two pins in the "LD" position, and the two pins in the "HM" position. The terminating resistor is not needed.

B DRIVE: Jumper the two pins in the "2" position, the two pins in the "LD" position, and the two pins in the "HM" position. The terminating resistor is needed.

9.4 HIGH-DENSITY (DRIVETEC) DRIVES

The high-density diskette drives are currently being offered in the KAYPRO ROBIE, and KAYPRO 4X. These are 5-1/4 inch, double-sided drives with 192 tracks per inch. Each drive has 160 cylinders with a total of 320 tracks and a formatted storage capacity of 2.6 megabytes.

HIGH-DENSITY DISKETTES

The diskettes used with the high-density drives MUST be pre-formatted 17 sector, 192 TPI diskettes.

DRIVE CONFIGURATION

Next to the connector for the data cable is a drive select switch— DS1 through DS4.

A DRIVE: DS1 should be in the "on" position. All other switches should be in the "off" position.

DRIVE: DS2 should be in the "on" position. All other switches should be in the "off" position.

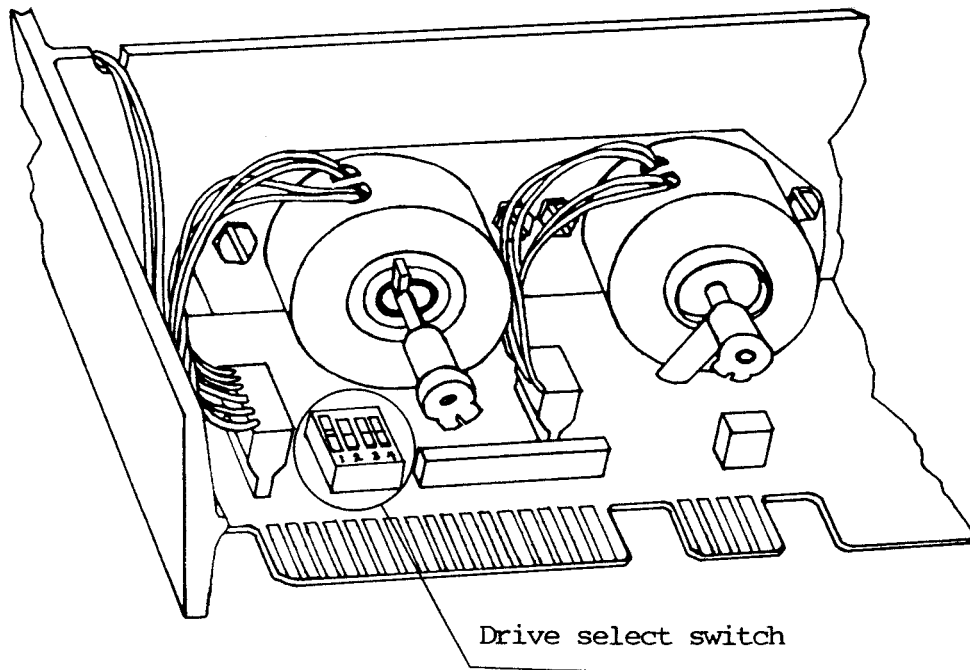

9.5 DISKETTE DRIVE REMOVAL

1. Turn off the machine and disconnect the AC power (5.1).
2. Remove the chassis hood (5.1).
3. Remove the data cable, power plug, and ground wire from the rear of the drive.
4. Remove the four screws that secure the drive in the drive shield.
5. Slide the drive out of the drive shield through the front of the machine.

Note: If the drive is hard to slide out of the drive shield unit, loosen the screws holding the other drive in place.

DISKETTE DRIVE INSTALLATION

1. Configure the new drive. (A Drive or B Drive) Refer to pages 9--5 to 9--8.
2. Slide the drive into the drive shield.
3. Align the mounting holes on the drive with the holes on the drive shield.
4. Insert four screws through the shield and into the drive mounting holes.
5. After all the screws are inserted, tighten them securely.
6. Replace the data cable, power plug, and ground wire on the rear of the new drive.
7. Replace the chassis hood.

10.0 HARD DISK DRIVES (KAYPRO 10)

10.1 INTRODUCTION

Kaypro Corporation uses hard disk drives from a number of different manufacturers. As with the diskette drives, all models of hard disk drives are functionally interchangeable.

No adjustments are meant to be made by dealers (or are made by Kaypro technicians, for that matter) on these hard drives. And, since recovering information from a hard disk which has "crashed" requires a clean room, no directions for performing such an operation are included in this manual. Be aware that true head crashes are very rare occurrences, however---most hard disk problems can be corrected without the need to replace the drive itself. (See the symptom-fix guide.) We cannot stress strongly enough that dealers instruct their customers to ALWAYS back up their data while working on a hard disk. In many cases NOTHING can be done about the loss of data in a hard-drive failure.

10.2 DESCRIPTION

The hard disk drives used in the KAYPRO 10 are industry standard, 5-1/4 inch half-height drives offering Winchester technology. This technology includes sealed media and drive heads, with an air filtration system that prevents contamination. Since the drives are sealed, there are no dealer serviceable components on the drive. The only authorized dealer service to the hard disk drives is drive configuration.

10.3 HARD DRIVE CONFIGURATION MICROSCIENCE

Figure 10.1
Microscience
9 Position Switch



There are two types of drive selection switch banks available on Microscience drives. One type has nine (9) switches and one type has ten (10) switches. These switches are located on the drive PCB next to the power plug.

9 POSITION SWITCH: Pins 1, 2, and 4 should be in the "up" position .

Figure 10.2
Microscience
10 Position Switch



10 POSITION SWITCH: Pins 1, 3, 4, and 10 should be in the up position.

Refer to Figures 10.1 and 10.2 for Microscience drive configuration.

SEAGATE

Figure 10.3
Seagate Hard Drive
Option shunt block

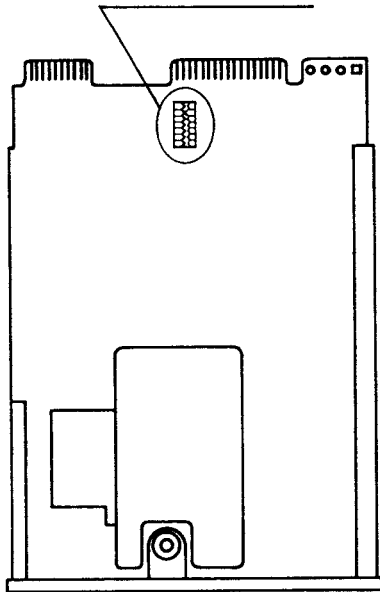

Next to the connector for the data cable, is a 16 pin option shunt block. Pins 7 and 10 should be jumpered.

Refer to figure 10.3 for Seagate drive configuration.

10.4 HARD DRIVE OR FLOPPY DRIVE REMOVAL FOR KAYPRO 10

For all hard drives and all diskette drives used in KAYPRO 10 computers.

Note: If the KAYPRO 10 has an Epson or Tokyo Electric diskette drive, it will be necessary to tilt the drive unit at an angle while removing or installing the drive. Refer to section 9.2 to determine the brand of drive.

Note: As you remove the cables on the KAYPRO 10, it's a good idea to label them. This will insure that they get replaced correctly. Also, the end of the data cable that has a different color wire (usually red) goes to pin #1 on the connector.

1. Turn off the machine and disconnect the AC power (5.1).
2. Remove the chassis hood (5.1).
3. Remove the two diagonal braces from the right side of the chassis.
4. Tilt the machine up so that the front of the machine is sitting on the work surface and parallel to the floor.
5. Remove the six screws from the bottom of the chassis that are under the drives. Set the machine back down.
6. Remove the ribbon cables from the mainboard.
7. Slide entire drive shield unit slightly to the rear, to make room for the face of the floppy to clear the opening.
8. Lift entire drive shield unit slightly and slide out the side of the chassis.

REMOVING THE DRIVES FROM THE DRIVE SHIELD

1. Remove the ribbon cables, power plug and the ground wire from the back of the drive (hard drive or floppy). Label these.
2. Remove the two screws that attach the bottom of the drive to the drive shield (hard drive or floppy).
3. Remove the two screws that attach the top of the drive to the drive shield.
4. Slide drive out through the front of the drive shield.

HARD DRIVE OR FLOPPY INSTALLATION FOR KAYPRO 10

1. Configure the new drive. Refer to page 10--3 for the hard drive, pages 9--5 to 9--8 for the floppy drive.
2. Slide the drive into the shield so that the mounting holes in the drive are aligned with those in the shield.
3. Insert two screws through the top of the shield and into the mounting holes of the drive.
4. Tighten these securely.
5. Insert two screws through the bottom of the shield and into the mounting holes of the drive.
6. Tighten these securely.
7. Replace the ribbon cable(s), power plug and ground wire.
8. Slide the entire drive shield unit into the chassis.
9. Align the mounting holes in the drive shield with those in the chassis.
10. Insert the six screws through the mounting holes and tighten securely.
11. Replace the two diagonal braces.
12. Replace the ribbon cable(s) on the mainboard.
13. Replace the chassis hood.

11.0 HARD DRIVE CONTROLLER BOARD

11.1 DESCRIPTION

The hard disk controller board used in the KAYPRO 10 is a Western Digital board, and is not dealer-serviceable.

11.2 REMOVAL/INSTALLATION INSTRUCTIONS

HARD DRIVE CONTROLLER BOARD REMOVAL

1. Turn off the machine and disconnect AC power (5.1).
2. Remove chassis hood (5.1).
3. Remove the two diagonal braces from the right side of the machine.
4. Remove the power plug and the three ribbon cables from the hard disk controller board. Label these to insure correct replacement.
5. Remove the three screws that attach the hard disk controller board and the drive shield.
6. Remove the board.

HARD DRIVE CONTROLLER BOARD INSTALLATION

1. Position the hard disk controller board so that the mounting holes in the board are aligned with the holes in the drive shield.
2. Insert the three screws and tighten securely.
3. Replace the power plug and the three ribbon cables.
4. Replace the two diagonal braces.
5. Replace the chassis hood (5.1).

12.0 INTERFACE BOARD, KAYPRO 10

12.1 DESCRIPTION

The interface board that is used on the KAYPRO 10 is the interface between the mainboard and the hard drive controller board. This board is not dealer serviceable.

13.0 KEYBOARDS

The 76-key alphanumeric, detachable keyboard is connected to the computer by a four-wire cable and is powered by +5 VDC through the cable. The CAPS LOCK indicator light allows a quick check on whether the keyboard is receiving power.

The impedance of the connecting cable can be a critical factor in proper operation of the computer. Replacement of the standard cable with a phone cord can create malfunctions in signal transmission to the computer. This is because the wire in phone cords is too small; therefore, the impedance over the total length of the cord can be too high for reliable operation.

Wire in the standard keyboard cable is 28-gage copper, and the cable length is six feet. Should you desire a longer keyboard cable, restrict the length to not more than twelve feet, and use wire no smaller than 28 gauge.

Keyboard Cable Pinouts

Pin 4 (Black) - Serial Data out (to keyboard), TTL level.
Pin 3 (Red) - Ground
Pin 2 (Green) - Serial data in (from keyboard), TTL level.
Pin 1 (Yellow) - +5 VDC

14.0 KAYPRO ROBIE REMOVAL/INSTALLATION INSTRUCTIONS

14.1 CHASSIS COVER REMOVAL

1. Turn off the machine and disconnect the AC power(5.1).
2. Remove the four screws securing the top chassis cover (two on each side of the machine).
3. Remove the eight screws securing the bottom chassis cover (four on each side of the machine).
4. Remove the two sections of the chassis cover from the machine.

CHASSIS COVER REPLACEMENT

1. Place the lower chassis cover on the machine and align the eight mounting holes with the mounting holes in the sides of the machine.
2. Insert the eight screws into the mounting holes and tighten securely.
3. Place the top chassis cover on the machine and align the four mounting holes with the mounting holes in the sides of the machine.
4. Insert the four screws into the mounting holes and tighten securely.

14.2 DISKETTE DRIVE REMOVAL

1. Remove the top chassis cover (5.1).
2. Remove the drive support unit from the chassis. There are three screws in the front and three screws in the rear.
3. Remove the ribbon cable and the power plugs from the drives.
4. Lift the drive support unit (drives still attached) off the chassis.
5. To remove either drive from the drive support unit, turn the unit over and remove the four screws that attach the specific drive to the support unit.

DISKETTE DRIVE REPLACEMENT

1. Align the drive mounting holes with the mounting holes in the drive support unit.
2. Insert four screws into the drive support unit and into the drive. Tighten these screws securely.
3. Set the drive support unit on the chassis and align the mounting holes in the support unit with those in the chassis.
4. Insert three screws into the front mounting holes and three screws into the rear mounting holes. Tighten these securely.
5. Replace the ribbon cable and the power plugs on the drives.

—> COLORED TAB: I/O AND REFERENCE

15.0 TROUBLESHOOTING

15.1 INTRODUCTION

The symptom—fix guide's information is based on our experience repairing Kaypro computers. The guide is a summary of the records that Kaypro Repair maintains on each computer received.

Fixes for each problem noted are presented in **descending** order of occurrence.

15.2 KAYPRO 2 AND 4 SYMPTOM—FIX GUIDE

CONDITION	POSSIBLE CAUSE	RECOMMENDED ACTION
No power, no lights, no video	Power cord not plugged in	Check all cord connections
	Fuse is blown	Replace fuse
	Mainboard not getting power	Check harness connections; check for proper voltages; replace either harness or power supply
	Defective mainboard	Replace mainboard
	Defective fuse holder	Replace fuse holder
	Power switch shorted internally	Replace power switch
	Power supply jumpered for wrong supply	Correct jumpering on power supply
	Defective power supply	Replace power supply
	Defective harness	Replace harness
Fuse blows when power is turned on	Defective power supply	Disconnect all modules from power supply; replace power supply if fuse still blows
	One module has a short	Disconnect all modules, replace fuse, and re-connect modules, one at a time, until fuse blows. Replace that module
	Defective harness	Replace harness
High-pitched squeal or "chirp"	One module is shorted	Unplug modules, one at a time, from the harness. Replace the module whose unplugging causes the noise to stop

KAYPRO 2 AND 4 SYMPTOM—FIX GUIDE (CONT'D)

CONDITION	POSSIBLE CAUSE	RECOMMENDED ACTION
Power LED flickers	Shorted module	Disconnect modules from power, one at a time, until LED stays on; replace module whose unplugging caused LED to stay on.
	Defective power supply	Replace power supply
	Defective harness	Replace harness
No video display, or poor quality display	Brightness not adjusted	Turn up brightness knob on rear of chassis; adjust brightness pot on CRT board, if necessary
	CRT not connected	Check all connections to CRT; be sure plug on rear of CRT tube is square
	Defective CRT	Replace CRT assembly
	Defective mainboard	Replace mainboard
	Defective power supply	Replace power supply
	Defective harness	Replace harness
Video is on, but screen is filled with "garbage" characters	Defective mainboard	Replace mainboard
	Reset harness shorted to chassis	Check lugs of reset button for grounding to inside of chassis
	Defective reset harness	Replace reset harness

KAYPRO 2 AND 4 SYMPTOM—FIX GUIDE (CONT'D)

CONDITION	POSSIBLE CAUSE	RECOMMENDED ACTION
"Raster" (horizontal lines) on video	Brightness not adjusted properly	Turn up brightness knob on back of chassis; adjust brightness pot on CRT board if necessary
	Loose connection from mainboard or power supply	Check black plug from power supply to CRT board, 4-pin jumper from main board to CRT board; check that plug on rear of CRT tube is square
Strange video image	Short in brightness-adjusting knob	Check for shorts between wires in rear of brightness-adjusting knob
	Defective mainboard	Replace mainboard
Missing characters on video display	Defective mainboard	Replace mainboard
	Defective CRT	Replace CRT assembly
Will not boot	Defective diskette	Change diskettes
	Diskette has no system image	Change diskettes; use a diskette with a known good system image
	Wrong CP/M for model of machine	Check that you're not trying to boot a KP 2 with a KP 4 CP/M (KP 4 WILL boot a KP 2 CP/M)
	Defective drive B	Unplug data cable from drive B, and reset machine; if it boots, replace drive B
	Defective mainboard	Replace mainboard
	Defective drive A	Replace drive A
	Defective data cable	Replace data cable

KAYPRO 2 AND 4 SYMPTOM—FIX GUIDE (CONT'D)

CONDITION	POSSIBLE CAUSE	RECOMMENDED ACTION
Both drive LEDs are on, won't boot	Problem on power-up	Reset machine
	Diskette has no CP/M	Try known good sysgenned diskette
	Defective mainboard	Replace mainboard
	Select jumpers on drives incorrect	Check select jumpers
Drive A LED only on during reset	Drive select jumpering incorrect	Check jumpering on drive A
No LED on drive A at any time	Data cable poorly connected	Check all connections on data cable
	Defective data cable	Replace data cable
	Defective drive A	Replace drive A
	Defective mainboard	Replace mainboard
Computer boots CP/M, but no A> prompt appears	Defective diskette	Try known good, sysgenned diskette
	Defective mainboard	Replace mainboard
Rattling sound from drive when accessing	Defective drive	Replace the diskette drive
	Defective mainboard	Replace mainboard

KAYPRO 2 AND 4 SYMPTOM—FIX GUIDE (CONTINUED)

CONDITION	POSSIBLE CAUSE	RECOMMENDED ACTION
Drive will not step through all tracks on diskette	Drive connectors loose	Check all connectors on rear of drive, esp. P12 (Tandon drives)
	Defective mainboard	Replace mainboard
	Defective drive	Replace diskette drive
	Defective data cable	Replace data cable
Errors on either drive during COPY	Defective diskette	Change the diskette (if problem is on drive B, insert another blank diskette; if on drive A, try to copy from a new master)
	Defective disk drive	Replace diskette drive
	Defective mainboard	Replace mainboard
No output to parallel printer	No power to printer	Check that printer is plugged in, and selected
	Poor cable connection	Check all cable connections from computer to printer
	Printer is assigned as serial by STAT	Use STAT to assign printer device as parallel, type: STAT LST:=LPT:
	Defective mainboard	Replace mainboard
No output to serial printer	No power to printer	Check that printer is plugged in and selected
	Poor cable connection	Check all cable connections from computer to printer; also check serial port connector pins for contamination
	Printer is assigned as parallel by STAT	Use STAT to assign printer device to serial; type: STAT LST:=TTY:

KAYPRO 2 AND 4 SYMPTOM—FIX GUIDE (CONTINUED)

CONDITION	POSSIBLE CAUSE	RECOMMENDED ACTION
No output to serial printer (cont'd)	Baud rate of printer does not match baud rate of computer	Use CONFIG to set baud rate for serial port
	Defective power supply	Check voltages (esp.-12 V) at power supply output; replace power supply
	Defective harness	Check voltages (esp.-12V) at main board power connector; replace harness
	Defective mainboard	Replace mainboard
No characters on video when keys struck on keyboard	Defective keyboard coil cord	Replace coil cord
	Defective keyboard	Replace keyboard
	Keyboard connector on mainboard defective	Check for shorted contacts on keyboard plug; esp. soldering to main board
	Defective mainboard	Replace mainboard
Wrong characters or too many characters appear when a key is struck	Defective keyboard	Replace keyboard
	Defective mainboard	Replace mainboard (if "^@^@@" appears, replace 8116 IC on mainboard)

15.3 KAYPRO 10 SYMPTOM—FIX GUIDE

IMPORTANT NOTE

Do not proceed with troubleshooting a Kaypro 10 until you verify that the computer has eeprom number 81-302-x (installed at the factory), or has been upgraded in the field with kit number 31-303 (consisting of eeprom number 81-302-x, a modified interface board, and a utilities reload diskette.)

CONDITION	POSSIBLE CAUSE	RECOMMENDED ACTION
No power, no lights, no video	Power cord not plugged in	Check all cord connections
	Fuse is blown	Replace fuse
	Mainboard not getting power	Check harness connections, then check for proper voltages from power supply; replace either harness or power supply
	Defective mainboard	Replace mainboard
	Defective fuse holder	Replace fuse holder
	Power switch shorted internally	Replace power switch
	Power supply jumpered for wrong supply voltage	Correct jumpering on power supply
	Defective power supply	Check for proper voltage output at power supply harness connector; replace power supply
	Defective harness	Replace harness
Fuse blows when power turned on	Defective power supply	Replace power supply
	One module has a short	Disconnect all modules, replace fuse, and re-connect one by one until fuse blows again; replace it
	Defective harness	Replace harness

KAYPRO 10 SYMPTOM—FIX GUIDE (CONT'D)

CONDITION	POSSIBLE CAUSE	RECOMMENDED ACTION
High-pitched squeal or "chirp" upon power-on	One module is shorted	Unplug modules, one at a time, from the harness. Replace the module whose unplugging causes the noise to stop.
Power LED flickers	Shorted module	Disconnect modules from power one at a time until LED stays on; replace module whose unplugging causes LED to stay on
	Defective power supply	Replace power supply
	Defective harness	Replace harness
No video display, or poor quality display	Brightness not adjusted	Turn up brightness knob on rear of chassis; turn up brightness pot on CRT board, if necessary
	CRT not connected	Check all connections to CRT; ensure CRT tube plug is square
	Defective CRT	Replace CRT assembly
	Defective mainboard	Replace mainboard
	Defective power supply	Replace power supply
	Defective harness	Replace harness
Extra pixels on video	Defective mainboard	Replace mainboard
	Defective CRT	Replace CRT assembly
Inverse video only	Defective mainboard	Replace mainboard
	Defective CRT	Replace CRT assembly

KAYPRO 10 SYMPTOM—FIX GUIDE (CONT'D)

CONDITION	POSSIBLE CAUSES	RECOMMENDED ACTION
No graphics on video	Damaged system image	Run PUTSYS and PUTOVL
	Defective mainboard	Replace mainboard
	Defective CRT	Replace CRT assembly
No video; drives running	Poor cable connection	Check all cable connections, (esp. to/from video harness plug)
	Defective mainboard	Replace mainboard
	Defective CRT	Replace CRT assembly
	Elston CRT: fuse blown	Check continuity of pico-fuse on Elston video board (just above power connector) If open, replace
Hard drive boots, but no cursor on video	Defective system image	Run PUTSYS and PUTOVL from the diskette drive, push RESET
	Defective mainboard	Replace mainboard
Diskette drive boots, but no cursor on video	Defective system image on diskette	Run GENFLPY on the diskette; push RESET
	Defective mainboard	Replace mainboard
	Defective drive	Replace diskette drive
Diskette drive won't boot; or BDCS error on diskette drive	Diskette not centered	Remove diskette, center diskette in its jacket; try again
	No system image on diskette	Run GENFLPY on the diskette; push RESET
	Defective diskette	Try a known good diskette with a known good system image

KAYPRO 10 SYMPTOM—FIX GUIDE (CONT'D)

CONDITION	POSSIBLE CAUSE	RECOMMENDED ACTION
Diskette drive won't boot; or BDOS errors	Poor cable connection	Check all cable connections; esp. those to/from drives and the controller board
	No system image	Run GENFLPY
	Incorrect cable orientation	Verify that all cables are oriented properly
	Defective mainboard	Replace mainboard
	Defective drive	Replace diskette drive
Diskette drive won't format a disk	Diskette off center	Ensure that diskette is centered within its jacket
	Defective diskette drive	Replace diskette drive
	Defective mainboard	Replace mainboard
Diskette drive has BDOS errors or won't work if warm	Defective drive heads	Replace diskette drive
	Defective mainboard	Replace mainboard
Diskette drive makes a rattling noise, and won't boot	Defective diskette drive	Replace diskette drive
	Defective mainboard	Replace mainboard
High-pitched whine when diskette drive runs	Defective diskette drive ("singing heads")	Replace diskette drive

KAYPRO 10 SYMPTOM—FIX GUIDE (CONT'D)

CONDITION	POSSIBLE CAUSE	RECOMMENDED ACTION
Hard drive will not boot; or boots with "System Status 02" ("Read Fault") message	Machine not upgraded	Verify installation of eeprom number 81-302-x (at the factory), or kit 81-303; install if needed
	Poor cable connection	Check all cable connections
	Incorrect cable orientation	Verify that all cables are oriented properly
	System image degraded	Boot on a disk in the diskette drive; then log onto hard drive. Run FINDBAD (or CHECK on cylinders 0 and 1) if no errors are found, run PUTSYS and PUTVOL
	Defective controller board	Replace controller board
	Degraded format on hard disk	Boot on a disk in the diskette drive; run FORMAT on entire hard drive; then run PUTSYS and PUTVOL
	Defective mainboard	Replace mainboard
	Defective hard drive	Replace hard drive
	Defective power supply	Replace power supply

Except in the case of an obvious head crash or brake assembly failure, ALWAYS suspect other modules first when a defect appears to be within the hard drive.

No output to parallel printer	No power to printer	Check that printer is plugged in, and selected
	Poor cable connection	Check all cable connections from computer to printer
	Printer is assigned as serial by STAT	Use STAT to assign printer device as parallel; type: STAT LST:=LPT:
	Defective mainboard	Replace mainboard

KAYPRO 10 SYMPTOM—FIX GUIDE (CONT'D)

CONDITION	POSSIBLE CAUSE	RECOMMENDED ACTION
No output to serial printer	No power to printer	Check that printer is plugged in and selected
	Poor cable connection	Check all cable connections from computer to printer; also check serial port connector pins for contamination
	Printer is assigned as parallel by STAT	Use STAT to assign printer device to serial; type: STAT LST:=TTY:
	Baud rate of printer does not match baud rate of computer	Use CONFIG to set baud rate for serial port
	Defective power supply	Check voltages (esp.-12 V) at supply output; replace supply
	Defective harness	Check voltages (esp.-12V) at main board power connector; replace harness
	Defective mainboard	Replace mainboard

15.4 KAYPRO ROBIE SYMPTOM—FIX GUIDE

CONDITION	POSSIBLE CAUSE	RECOMMENDED ACTION
No power, no lights, no video	Power cord not plugged in	Check all cord connections
	Fuse is blown	Replace fuse
	Mainboard not getting power	Check harness connections; check for proper voltages; replace either harness or power supply
	Defective mainboard	Replace mainboard
	Defective power supply	Replace power supply
	Defective harness	Replace harness
Fuse blows when power is turned on	Defective power supply	Disconnect all modules from power supply; replace power supply if fuse still blows
	One module has a short	Disconnect all modules, replace fuse, and re-connect modules, one at a time, until fuse blows. Replace that module
	Defective harness	Replace harness
High-pitched squeal or "chirp"	One module is shorted	Unplug modules, one at a time, from the harness. Replace the module whose unplugging causes the noise to stop
No video display	Brightness not adjusted	Turn up brightness knob on rear of chassis; turn up brightness pot on CRT board, if necessary
	CRT not connected	Check all connections to CRT; be sure plug on rear of CRT tube is square

KAYPRO ROBIE SYMPTOM—FIX GUIDE (CON'T.)

CONDITION	POSSIBLE CAUSE	RECOMMENDED ACTION
No video display	Defective CRT	Replace CRT assembly
	Defective mainboard	Replace mainboard
	Defective power supply	Replace power supply
	Defective harness	Replace harness
Video is on, but screen is filled with "garbage" characters	Defective mainboard	Replace mainboard
	Reset harness shorted to chassis	Check lugs of reset button for grounding to inside of chassis
	Defective reset harness	Replace reset harness
"Raster" (horizontal lines) on video	Brightness not adjusted properly	Turn up brightness knob on back of chassis; adjust brightness pot on CRT board if necessary
	Loose connection from mainboard or power supply	Check black plug from power supply to CRT board, 4-pin jumper from mainboard to CRT board; check that plug on rear of CRT tube is square
Strange video image	Defective mainboard	Replace mainboard
Missing characters on video display	Defective mainboard	Replace mainboard
Will not boot	Defective diskette	Change diskettes
	Diskette has no system image	Change diskettes; use a diskette with a known good system image
	Wrong diskette for model of machine	ROBIE will only boot on 17 sector, 192 TPI diskettes
	Defective drive B	Unplug data cable from drive B, and reset machine; if it boots, replace B drive

KAYPRO ROBIE SYMPTOM—FIX GUIDE (CON'T.)

CONDITION	POSSIBLE CAUSE	RECOMMENDED ACTION
Will not boot	Defective mainboard	Replace mainboard
	Defective drive A	Replace drive A
	Defective data cable	Replace data cable
Both drive LEDs are on, won't boot	Problem on power-up	Reset machine
	Diskette has no CP/M	Try known good sysgenned diskette
	Defective mainboard	Replace mainboard
	Select jumpers on drives incorrect	Check select jumpers
Drive A LED only on during reset	Drive select jumpering incorrect	Check jumpering on drive A
No LED on drive A at any time	Data cable poorly connected	Check all connections on data cable
	Defective data cable	Replace data cable
	Defective drive A	Replace drive A
	Defective mainboard	Replace mainboard
Computer boots CP/M, but no master menu appears	Defective diskette	Try known good, sysgenned diskette
	Defective drive A	Replace drive A
	Defective mainboard	Replace mainboard
Rattling sound from drive when accessing	Defective drive	Replace the diskette drive
	Defective mainboard	Replace mainboard

KAYPRO ROBIE SYMPTOM—FIX GUIDE (CONT'D.)

CONDITION	POSSIBLE CAUSE	RECOMMENDED ACTION
Drive will not step through all tracks on diskette	Drive connectors loose	Check all connectors on rear of drive
	Defective mainboard	Replace mainboard
	Defective drive	Replace diskette drive
	Defective data cable	Replace data cable
Errors on either drive during COPY	Defective diskette	Change the diskette (if problem is on drive B, insert another blank diskette; if on drive A, try to copy from a new master)
	Defective disk drive	Replace diskette drive
	Defective mainboard	Replace mainboard
No output to parallel printer	No power to printer	Check that printer is plugged in, and selected
	Poor cable connection	Check all cable connections from computer to printer
	Printer is assigned as serial by STAT	Use STAT to assign printer device as parallel, type: STAT LST:=LPT:
	Defective mainboard	Replace mainboard
No output to serial printer	No power to printer	Check that printer is plugged in and selected
	Poor cable connection	Check all cable connections from computer to printer; also check serial port connector pins for contamination

KAYPRO ROBIE SYMPTOM—FIX GUIDE (CONT'D.)

CONDITION	POSSIBLE CAUSE	RECOMMENDED ACTION
No output to serial printer (cont'd)	Printer is assigned as parallel by STAT	Use STAT to assign printer device to serial; type: STAT LST:=TTY:
	Baud rate of printer does not match baud rate of computer	Use CONFIG to set baud rate for serial port
	Defective power supply	Check voltages (esp.-12 V) at power supply output; replace power supply
	Defective harness	Check voltages (esp.-12V) at main board power connector; replace harness
	Defective mainboard	Replace mainboard
No characters on video when keys struck on keyboard	Defective keyboard coil cord	Replace coil cord
	Defective keyboard	Replace keyboard
	Keyboard connector on mainboard defective	Check for shorted contacts on keyboard plug; esp. soldering to main board
	Defective mainboard	Replace mainboard
Wrong characters	Defective keyboard	Replace keyboard

15.5 KAYPRO 2/84 AND KAYPRO 2X SYMPTOM--FIX GUIDE

See KAYPRO 2 AND 4 SYMPTOM--FIX GUIDE for the 2/84. The problems and solutions will not be different.

For troubleshooting information on the KAYPRO 2X, see the KAYPRO 2 AND 4 SYMPTOM--FIX GUIDE for all problems.

15.6 KAYPRO 4X SYMPTOM-FIX GUIDE

For help in troubleshooting the KAYPRO 4X, see the KAYPRO ROBBIE SYMPTOM--FIX GUIDE.

16.0 KAYPRO SYSTEM I/O

16.1 VIDEO COMMAND PROTOCOL

The Kaypro video section was originally designed to imitate most of the control sequences of a Lear-Siegler ADM-3A terminal. For most commercial software, this meant that you could "install" or customize the display characteristics by choosing ADM-3A from the menu.

For custom software or those instances where there is no choice of "ADM-3A" on the menu, the complete command protocol for the KAYPRO 2, 4, or 10 is:

Control Characters

Action	Dec	Hex
Ring Bell	07	07
Cursor left (non-destructive)	08	08
Cursor Right	12	0C
Cursor Down	10	0A
Cursor Up	11	0B
Erase to end of screen	23	17
Erase to end of line	24	18
Clear screen, home cursor	26	1A
Home cursor	30	1E

ESCAPE Sequences

Insert line	ESCAPE,R
Delete line	ESCAPE,E
Cursor address	ESCAPE,=,row+32,col+32

* Additionally, the following codes apply to: KAYPRO 2/84, 2X, 4/84, 4X, 10, and ROBIE (KAYPRO computers with graphics capability):

Reverse video start	ESCape,B,0
Reverse video stop	ESCape,C,0
Half intensity start	ESCape,B,1
Half intensity stop	ESCape,C,1
Blinking start	ESCape,B,2
Blinking stop	ESCape,C,2
Underline start	ESCape,B,3
Underline stop	ESCape,C,3
Cursor on	ESCape,B,4
Cursor off	ESCape,C,4
Video mode on	ESCape,B,5
Video mode off	ESCape,C,5
Remember current cursor position	ESCape,B,6
Return to last remembered cursor position	ESCape,C,6
Status line preservation on	ESCape,B,7
Status line preservation off	ESCape,C,7
Set pixel	ESCape*,V1,H1
Clear pixel	ESCape,V1,H1
Set line	ESCape,L,V1,H1,V2,H2
Delete line	ESCape,D,V1,H1,V2,H2

16.2 KEYBOARD CODES AND FUNCTIONS

Control key functions in CP/M:

DEL	Delete and echo the last character typed at the console (same as rubout).
CTRL-C	CP/M system reboot (warm start).
CTRL-E	Physical, not logical, end of line. Carriage is returned, but line is not sent until RETURN key is pressed.
CTRL-G	Bell; sounds an audible bell (from keyboard).
CTRL-H	Backspace; move cursor left one character position.
CTRL-I	Horizontal tab, moves cursor to the next defined tab stop. (CP/M assumes tab stops at every 8th position.
CTRL-J	Linefeed: move cursor down one line.
CTRL-M	Carriage return; return cursor to left margin.
CTRL-R	Retype current command line. Types a "clean line" following character deletion with rubouts.
CTRL-U	Delete the entire line typed at the console.
CTRL-X	Same as CTRL-U.

SEE ALSO: ASCII character chart, Section 17.1.

16.3 CONNECTOR PIN-OUTS

This section contains drawings of the pin assignments on various output ports on Kaypro computers, intended as an aid in building printer cables and in troubleshooting problems with peripherals.

CONNECTOR PIN-OUTS, KAYPRO 2/83 AND KAYPRO 4/83

PARALLEL PRINTER PORT: J2

STROBE	1	19	
(LSB) DATA 0	2	20	
DATA 1	3	21	
DATA 2	4	22	
DATA 3	5	23	
DATA 4	6	24	
DATA 5	7	25	GROUND
DATA 6	8	26	
(MSB) DATA 7	9	27	
N/C	10	28	
BUSY (IN)	11	29	
	12	30	
	13	31	
N/C	14	32	N/C
	15	33	GROUND
	16	34	
GROUND	17	35	N/C
N/C	18	36	

Top of connector

Bottom of connector

Note that the BUSY line is read by the KAYPRO as active when it's disconnected (no cable). The computer will hang if you attempt to print to an unconnected parallel printer.

KAYPRO 2/83 AND KAYPRO 4/83 KEYBOARD CONNECTOR (J3)

TxD	4	2	RxD
GND	3	1	+5V

KAYPRO 2/83 AND KAYPRO 4/83 SERIAL PORT (RS232C — J4)

GROUND	1	
		14
TxD	2	15
RxD	3	16
	4	17
CTS	5	18
	6	19
GROUND	7	20 DTR
	8	21
	9	22
	10	23 N/C
N/C	11	24
	12	25
	13	

Top of connector
Bottom of connector

KAYPRO 10 MODEM PORT (J3)

GROUND	1	14	
TxD	2	15	
RxD	3	16	
RTS	4	17	
CTS	5	18	
+5V	6	19	
GROUND	7	20	DTR
DCD	8	21	
	9	22	
	10	23	
	11	24	
	12	25	
	13		

Top of connector Bottom of connector

KAYPRO 10 KEYBOARD CONNECTOR (J5)

The pin-out for this connector is the same as J3 on the KAYPRO 2/83 and KAYPRO 4/83. See page 16---6.

KAYPRO 10 PARALLEL PRINTER CONNECTOR (J6)

The pin-out for this connector is the same as J2 on the KAYPRO 2/83 and KAYPRO 4/83. See page 16---5.

KAYPRO 10 SERIAL PRINTER PORT (RS232C — J4)

GROUND	1	
	2	14
RxD	3	15
TxD	4	16
	5	17
	6	18
GROUND	7	19
	8	20 CTS
	9	21
	10	22
	11	23 N/C
	12	24
	13	25

Top of connector

Bottom of connector

KAYPRO 2/84, 2X, 4/84, 4X AND ROBIE KEYBOARD CONNECTOR (J2)

The pin-out for this connector is the same as J3 on the KAYPRO 2/83 and KAYPRO 4/83. See page 16--6.

KAYPRO 2/84, 2X, 4/84, 4X AND ROBIE SERIAL DATA CHANNEL (J4)

The pin-out for this connector is the same as J4 on the KAYPRO 2/83 and KAYPRO 4/83. See page 16--6.

KAYPRO 2/84, 2X, 4/84, 4X AND ROBIE SERIAL PRINTER CONNECTOR (J3)

GROUND	1	
	14	
RxD	2	
	15	
TxD	3	
	16	
	4	
	17	
N/C	5	
	18	
	6	
	19	
GROUND	7	
	20	CTS
	8	
	21	
	9	
	22	
	10	
	23	N/C
N/C	11	
	24	
	12	
	25	
	13	

KAYPRO 2/84, 2X, 4/84, 4X AND ROBIE PARALLEL PRINTER CONNECTOR (J5)

PSTROB	1	19	
D0	2	20	
D1	3	21	
D2	4	22	
D3	5	23	
D4	6	24	
D5	7	25	
D6	8	26	GROUND
D7	9	27	
	10	28	
	11	29	
	12	30	
	13	31	
	14	32	
	15	33	
GROUND	16	34	GROUND
	17	35	
SPARE	18	36	

KAYPRO 4/84, 4X AND ROBIE MODEM CONNECTOR (J6)

Note that this is NOT connected on the 2/84 and 2X.

N/C	1		
		2	N/C
TIP (Green)	3		
		4	RING (Red)
N/C	5		
		6	N/C

16.4 I/O PORT ADDRESSES

The port addresses below apply to KAYPRO 2/83 and 4/83 computers.

Port #	Use and/or Assignment
00	Baud Rate (write only) - Writing a number between 0 and F hex (see baud rate table) to this port sets the RS-232C baud rate.
04	RS-232C Serial Data (R/W) - Data register of the Z-80 SIO. Refer to Zilog/Mostek Microcomputer Data books for further information.
05	Keyboard Data (R/W) - Eight-bit data from detachable keyboard.
06	RS-232C Status (R/W) - Control/status port for the Z-80 SIO. Refer to Zilog/Mostek Microcomputer Data books for further information.
08	Printer Port (write only) - Eight-bit data to parallel printer connector.
1C	System Port (R/W) - This port is used for system control. The various bits are used for memory bank selection, disk drive control, and printer handshaking.

The serial output is an 8-bit word with one start, one stop, and no parity.

Examples:

- * Received character available is obtained by testing bit 0 of the status port. Character is available if this bit is high (a 1 rather than 0).
- * Transmit Buffer Empty is obtained by testing bit 2 of the status port. Buffer is empty when bit 2 is high (1).

Manuals on the Z-80 CPU, Z-80 PIO, Z-80 SIO are available from the ZILOG sales office nearest to you. Western Digital can sell you a copy of the manual for the Floppy Disk Controller. Refer to Reference Section for vendors' mailing addresses and phone numbers.

When ordering manuals for any of the chips mentioned above, remove the hood from the computer and write down the full model number that is on the top surface of the chip. This is the best way to be certain of getting the proper manual from either of the manufacturers listed above.

The following port address information applies to KAYPRO 10, KAYPRO 2/84, KAYPRO 2X, KAYPRO 4/84, KAYPRO 4X, and KAYPRO ROBIE.

I/O PORT ADDRESSES

<u>Use</u>	<u>Port# (hex)</u>	<u>Device</u>	<u>Function</u>
Keyboard:			
	05	ZSIO 1 Chan. B	Keyboard data(R/W). Eight-bit data from keyboard.
	07	ZSIO 1 Chan. B	Keyboard control/status I/O.
Video:			
	1C	6545/6845 EA	CRT controller status/control I/O.
	1D	6545/6845 EA	CRT controller data I/O.
<hr/> <hr/>			
Parallel Printer: (output only)			
	18 - 1B	74 373	Parallel printer port (write only).
<hr/> <hr/>			
Serial Printer I/O:			
	08 - 0B	WD 1943 COM 8116	Baud rate for serial printer port.
	0C	ZSIO 2 Chan. A	Serial printer data I/O (RS-232C).
	0E	ZSIO 2 Chan. A	Serial printer control/status I/O.
<hr/> <hr/>			
Serial Data I/O:			
	00 - 03	WD 1943 COM 8116	Baud rate for serial data port (write only).
	04	ZSIO 1 Chan. A	Serial data port (RS-232C). Data I/O.
	06	ZSIO 1 Chan. A	Serial data port (RS-232C). Status/control I/O.

<u>Use</u>	<u>Port#</u> <u>(hex)</u>	<u>Device</u>	<u>Function</u>
Real-time clock:	20	(NS-MM58167A) PIO Chan. A	Real-time clock register select and interrupt status.
			Bit functions:
			0 lsb register select (output).
			1 "
			2 "
			3 "
			4 msb register select (output).
			5 not used
			6 rtc interrupt output (input).
			7 rtc not standby interrupt output (input).
	22	PIO Chan. A	Real-time clock PIO control port.
	24	MM 58167A	Real-time clock data I/O.

<u>Use</u>	<u>Port# (hex)</u>	<u>Device</u>	<u>Function</u>
System:	14 - 17	74 373	System output port. Bit functions. 0 0=Select floppy A (C on K10). 1 0=Select floppy B (Hard disk on K10). 2 0=Select side 2. 3 PSTROB 4 0=Floppy motor on (48 tpi drives). 1=Select high speed (High density drive). * see note 5 0=Select double-density. 6 0=Select normal character set. 7 0=Select 64K RAM. 1=Select ROM (RAM 8000-FFFF).
		74 244	System input port. Bit functions. 0 0=floppy A selected (C on K10). 1 0=floppy B selected (Hard disk on K10). 2 0=Side 2 selected. 3 PSTROB. 4 0=motor is on (48 tpi floppy). 5 0=Double-density is selected. 6 0=Parallel printer is busy. 7 0=64K RAM is selected. 1=ROM (RAM 8000-FFFF) selected.

* Note on high-density drives:

A 1 in bit position 4 will select high speed on the high-density diskette drive. To reset the drive to low speed it is necessary to change this bit to a 0 AND open the drive door, then close it.

<u>Use</u>	<u>Port# (hex)</u>	<u>Device</u>	<u>Function</u>
Internal Modem:			
	0D	ZSIO 2 Chan. B	Internal modem data I/O port.
	0F	ZSIO 2 Chan. B	Internal modem status/control I/O port.
	21	PIO Chan. B	Internal modem control lines. Bit functions. 0 lsb digit to dial (output). 1 " 2 " 3 msb digit to dial (output). 4 0=touch tone. 1=pulse dial. -ate on modem chip. 5 0=not loop back (test mode). 6 0=off hook (on line). 7 1=digit present to dialer chip, not BSTROBE input present next digit from dialer chip.
	23	PIO Chan. B	Modem PIO control port.

The internal modem on the KAYPRO uses Texas Instruments TMS99531 dialer and TMS99532 modem chips. Both of these chips are accessed through the Z80 PIO and Z80 SIO chips. Specification sheets on these chips are available from Texas Instruments and ZILOG respectively.

Disk Controller Ports:

10	1793	Floppy disk controller status/command I/O port.
11	1793	Floppy disk controller track register I/O port.
12	1793	Floppy disk controller sector register I/O port.
13	1793	Floppy disk controller data register I/O port.

<u>Use</u>	<u>Port# (hex)</u>	<u>Device</u>	<u>Function</u>
	80	WD 1002	Hard disk controller card data I/O port.
	81		Error Register (input). Write Precomp. (output).
	82		Sector count register I/O.
	83		Sector number register I/O.
	84		Cylinder low register I/O.
	85		Cylinder high register I/O.
	86		Size/drive/head register I/O.
	87		Status register for input. Command register for output.

17.0 REFERENCE SECTION

17.1 ASCII CHART

Dec	Hex	Char	Dec	Hex	Char	Dec	Hex	Char	Dec	Hex	Char
0	00	NUL or ^@	32	20	Space	64	40	@	96	60	`
1	01	SCH or ^A	33	21	!	65	41	A	97	61	a
2	02	STX or ^B	34	22	"	66	42	B	98	62	b
3	03	ETX or ^C	35	23	#	67	43	C	99	63	c
4	04	EOT or ^D	36	24	\$	68	44	D	100	64	d
5	05	ENQ or ^E	37	25	%	69	45	E	101	65	e
6	06	ACK or ^F	38	26	&	70	46	F	102	66	f
7	07	BEL or ^G	39	27	'	71	47	G	103	67	g
8	08	BS or ^H	40	28	(72	48	H	104	68	h
9	09	HT or ^I	41	29)	73	49	I	105	69	i
10	0A	LF or ^J	42	2A	*	74	4A	J	106	6A	j
11	0B	VT or ^K	43	2B	+	75	4B	K	107	6B	k
12	0C	FF or ^L	44	2C	,	76	4C	L	108	6C	l
13	0D	CR or ^M	45	2D	-	77	4D	M	109	6D	m
14	0E	SO or ^N	46	2E	.	78	4E	N	110	6E	n
15	0F	SI or ^O	47	2F	/	79	4F	O	111	6F	o
16	10	DLE or ^P	48	30	0	80	50	P	112	70	p
17	11	DC1 or ^Q	49	31	1	81	51	Q	113	71	q
18	12	DC2 or ^R	50	32	2	82	52	R	114	72	r
19	13	DC3 or ^S	51	33	3	83	53	S	115	73	s
20	14	DC4 or ^T	52	34	4	84	54	T	116	74	t
21	15	NAK or ^U	53	35	5	85	55	U	117	75	u
22	16	SYN or ^V	54	36	6	86	56	V	118	76	v
23	17	ETB or ^W	55	37	7	87	57	W	119	77	w
24	18	CAN or ^X	56	38	8	88	58	X	120	78	x
25	19	EM or ^Y	57	39	9	89	59	Y	121	79	y
26	1A	SUB or ^Z	58	3A	:	90	5A	Z	122	7A	z
27	1B	ESC or ^[59	3B	;	91	5B	[123	7B	{
28	1C	FS or ^\	60	3C	<	92	5C	\	124	7C	
29	1D	GS or ^]	61	3D	=	93	5D]	125	7D	}
30	1E	RS or ^^	62	3E	>	94	5E	^	126	7E	~
31	1F	US or ^_	63	3F	?	95	5F	_	127	7F	DEL

MEMORY MAP OF KAYPRO 2 AND KAYPRO 4

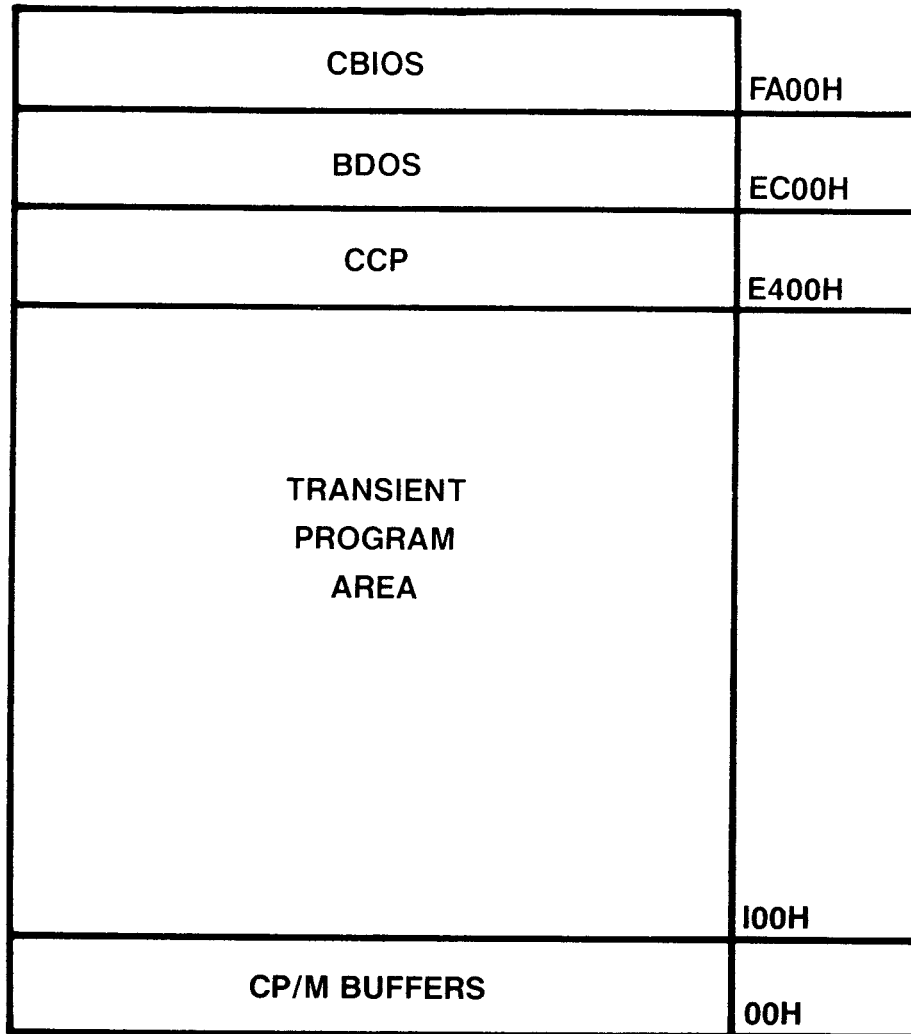

MEMORY MAP OF KAYPRO 10

CBIOS	EA00H
BDOS	DC00H
CCP	D400H
TRANSIENT PROGRAM AREA	I00H
CP/M BUFFERS	00H

MEMORY MAP OF KAYPRO 2/84 AND 4/84

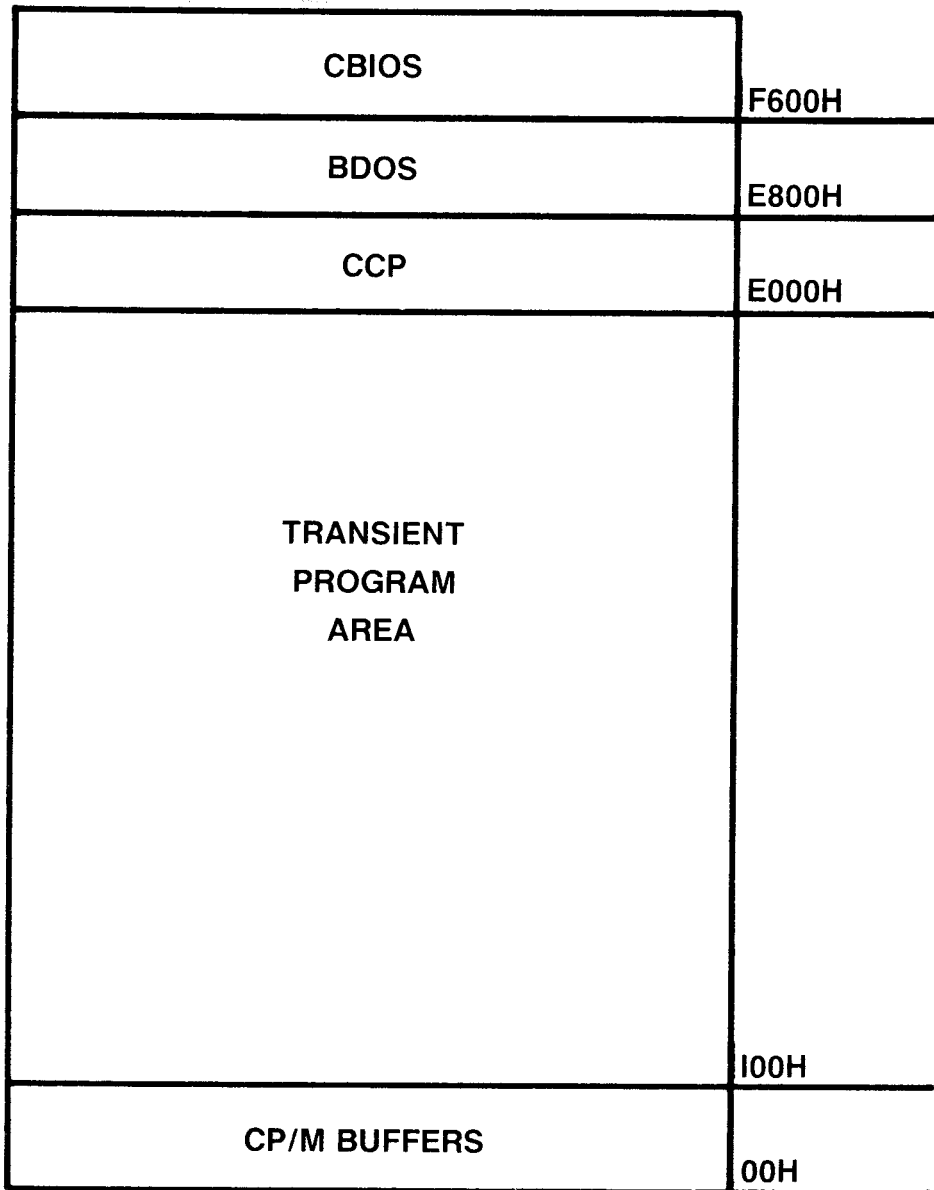

MEMORY MAP OF KAYPRO ROBIE

CBIOS	F200H
BDOS	E400H
CCP	DC00H
TRANSIENT PROGRAM AREA	I00H
CP/M BUFFERS	00H

17.4 VENDOR ADDRESSES

Kaypro Corporation does not provide repair or reference manuals for other companies' products which are used in Kaypro computers. The list below does not presume to be complete, but is included for dealer convenience in ordering manuals directly from the manufacturer.

Drives

Drivetec
2140 Bering Drive
San Jose, Ca. 95131
(408) 946-2222

Epson
17752 Skypark #255
Irvine, Ca 92714
(714) 250-0111

HI-TEC
10150 Sorrento Valley Rd.
San Diego, Ca. 92121
(619) 452-5500

Microscience
575 E. Middlefield Road
Mountain View, Ca. 94043
(415) 961-2212

Seagate
920 Disc Drive
Scotts Valley, Ca. 95066
(408) 438-6550

Shugart
475 Oakmead Parkway
Sunnyvale, Ca. 94086
(408) 733-0100

Tandon
20320 Prairie St.
Chatsworth, Ca. 91311
(213) 993-6644

TEC
1000 E. Walnut St.
Pasadena, Ca. 91106
(213) 681-5631

Toshiba
9030 Carroll Canyon #7
San Diego, Ca. 92121
(619) 578-9171

Integrated Circuits

Mostek
18004 Skypark Circle
Suite 140
Irvine, Ca. 92714
(714) 250-0455

National Semiconductor
2900 Semiconductor Drive
Santa Clara, Ca. 95051
(408) 737-5000

Texas Instruments
17620 Fitch
Irvine, Ca. 92714
(714) 545-5210

Western Digital
3128 Red Hill Ave.
Costa Mesa, Ca. 92626

Zilog
18023 Skypark Circle
Suite J
Irvine, Ca. 92714
(714) 549-2891

CRT Assemblies

Audiotronics
7420 Belair Ave.
N. Hollywood, Ca. 91605
(213) 765-2645

Dotronix
160 1st Street S. E.
New Brighton, MN. 55112
(612) 633-1742

Elston
35 Lehigh Street
Geneva, N.Y. 14456
(315) 781-1350

Toshiba
9030 Carroll Canyon #7
San Diego, Ca. 92121
(619) 578-9171

Keyboards

Keytronics
7032 Owensmouth
Canoga Park, Ca. 91303
(714) 832-1685

Maxi-Switch
9697 E. River Road
Minneapolis, MN. 55433
(612) 755-7660

SMK
4617 Ruffner Street #206
San Diego, Ca. 92111
(619) 560-8330

Power Supplies

Astec
1101 Space Park
Santa Clara, Ca. 95050
(408) 727-3350

Boschert
384 Santa Trinita Ave.
Sunnyvale, Ca. 94086
(408) 732-2240

Cal D.C.
2150 Anehor Court
Newbury Park, Ca. 91320
(805) 499-3621

Disk Controller Board

Western Digital
2445 McCabe Way
Irvine, Ca. 92714
(714) 863-0102

18.0 SUGGESTED REFERENCES

KAYPRO II Theory of Operation, by Dana Cotant—Micro Cornucopia,
P.O. Box 223 - Bend, OR. 97709

Modern Dictionary of Electronics, by Rudolf F. Graf, Radio Shack Catalog
Number 62-2310

Some **colored markers or pencils** with which to mark the chip layout diagrams in this manual according to function (video, disk control, etc.) will be useful. Such "maps" can be time-saving devices. (Because of printing costs and problems, Kaypro is unable to supply colored "maps" in the Technical Manual.)

The **CP/M Manual** included with each KAYPRO. You can devise excellent and effective tests for the machines through imaginative use of CP/M programs like PIP, SUBMIT, XSUB. To this end, books about CP/M (with an emphasis on programming; not for the beginner) can be helpful.

A good book containing information on the **Z80 microcomputer** and its family (SIO, PIO). Timing diagrams (or scope signals) in these books can help troubleshoot mainboards.

Any **component repair manuals** you feel necessary. See Section 17.4 for vendor addresses.

20.0 KAYPRO 16/2

The KAYPRO 16/2 is an Intel 8088 microprocessor based computer that is similar in many ways to the KAYPRO 16 computer. Because of these similarities, Section 19 in the Technical Manual is used as a reference for the KAYPRO 16/2. The KAYPRO 16/2 is equipped with two double-density, double-sided disk drives providing 360K of storage per diskette. This is the main difference between the KAYPRO 16/2 and the KAYPRO 16.

The three cards that are used in the KAYPRO 16/2 are the same as those used in the KAYPRO 16 with one exception: SW1 on the processor card is set differently.

The settings for SW1 on the processor card are:

- Position 1 is on.
- Position 2 is off.
- Position 3 is on.
- Position 4 is on.
- Position 5 is off.

The mainboard is the same with these exceptions: J1, U73, U74, U77, U78, U79, U80, U81, U82, U91, U95, U96 and U97 are deleted.

The keyboard, CRT assembly, power supply, and fan are the same as those used in the KAYPRO 16.

Refer to Section 19 in the Technical Manual for adjustment procedures, removal/replacement of components and information regarding the following topics for the KAYPRO 16/2:

CHASSIS HOOD REMOVAL/REPLACEMENT	19-3
SYSTEM BOARDS	19-4
BOARD ASSEMBLY REMOVAL/REPLACEMENT	19-16
CARD REMOVAL/REPLACEMENT	19-18
MAINBOARD REMOVAL/REPLACEMENT	19-21
CRT ASSEMBLY ADJUSTMENTS	19-23
CRT REMOVAL/REPLACEMENT	19-24
POWER SUPPLY	19-26
220V CONFIGURATION	19-27
POWER SUPPLY REMOVAL/REPLACEMENT	19-29
KEYBOARD	19-41
PARALLEL PORT	19-42
I/O CONNECTORS	19-43
SERIAL PORT	19-44
EXTERNAL VIDEO MONITORS	19-47

DISKETTE DRIVES

The diskette drives in the KAYPRO 16/2 are the same double-density, double-sided drives used in other models of Kaypro computers. The brands that are currently being used are Epson, Shugart, Tokyo Electric and Toshiba. These drives are all functionally the same and therefore interchangeable.

Refer to the illustrations of the drives on pages 9-2 through 9-8 of the Technical Manual for identification and jumpering instructions.

The diskette drives used in the KAYPRO 16/2 are both jumpered using the instructions for jumpering the B drive, with one exception; the drive in the B position needs a terminating resistor and the drive in the A position does not. The B drive is the drive farthest from the CRT assembly and is the last drive on the ribbon cable.

DISKETTE DRIVE REMOVAL

1. Follow the instructions on page 19-3 of the Technical Manual and remove the chassis hood.
2. Remove the 34-pin ribbon cable, the power plug and the ground wire from both diskette drives.
3. Position the computer so that the rear of it is on the work surface and the bottom is facing you.
4. Remove three of the four screws that attach the drive shield and the bottom of the chassis.
5. Support the drives while removing the final screw that attaches the drive shield and the chassis.
6. Remove the two diagonal braces from the side of the chassis.
7. Remove the drive shield unit (the drives are still attached) from the chassis.
8. Remove the four screws that attach the bottom of the drives to the drive shield. Remove this portion of the drive shield.
9. There are two screws that attach each drive to the drive shield. Remove the two screws that attach the drive being replaced and the drive shield.
10. Remove the drive from the drive shield.

DISKETTE DRIVE REPLACEMENT

For diskette drive replacement, verify that the drive is jumpered correctly and reverse the preceding instructions.

Note: The ribbon cable has two twists in it for wires 10 through 16. A standard point to point cable will not work.

INDEX

220V configuration, 8--2
align.mac, 7--5
aligning CRT yoke, 7--2
ASCII chart, 17--1
brightness, 7--2
chassis hood, 5--1
CRT adjustments, 7--1
CRT assembly removal, 7--8
CRT descriptions, 7--1
disk drive cleaning, 9--1
diskette drive configuration, 9--5
diskette drive identification, 9--2
diskette drives, 9--1
Drivetec, 9--9
focus, 7--2
fuse, 8--2
hard disk drive, 10--1
hard drive configuration, 10--3
hard drive controller board, 11--1
hard drive removal, 10--4
high-density (Drivetec) drives, 9--9
horizontal centering, 7--1
horizontal hold, 7--2
horizontal width, 7--1
I/O port addresses, 16--10
interface board KAYPRO 10, 12--1
internal modem, 16--14
KAYPRO 10 block diagram, 6--18
KAYPRO 10 specifications, 3--1
KAYPRO 2 and 4 block diagram, 6--6
KAYPRO 2 specifications, 3--1
KAYPRO 2/84 and 2X specifications, 3--2
KAYPRO 4 specifications, 3--3
KAYPRO 4/84 specifications, 3--4
KAYPRO 4X specifications, 3--5
KAYPRO ROBIE specifications, 3--7
keyboard, 13--1
keyboard codes and functions, 16--3
keyboard connector, 16--6
mainboard removal, 6--51
mainboards, 6--1
memory maps, 17--3
modem port KAYPRO 10, 16--7
parallel printer port, 16--5
power supplies, 8--1
power supply removal, 8--5
real-time clock, 16--12
ROBIE removal/installation, 14--1
serial port KAYPRO 2 and 4, 16--6
serial printer port KAYPRO 10, 16--7.1
touch-up information, 5--2
troubleshooting, 15--1
vendor addresses, 17--6
vertical size and linearity, 7--1
video alignment, 7--3
video command protocol, 16--1